

San Telequip (P) Ltd.,  
504 & 505, Deron heights, Opp Mahabaleshwar hotel  
Baner Road, Baner Pune 411 045  
Phone : 020-, 65001587  
email : [info@santelequip.com](mailto:info@santelequip.com)

---



# USER MANUAL FOR GW BMS

## Table of Contents

<b>1 INTRODUCTION</b>	<b>3</b>
<b>2 SPECIFICATIONS</b>	<b>3</b>
<b>3 OPERATION</b>	<b>4</b>
<b>4 REMOTE USER INTERFACE</b>	<b>4</b>
<b>5 USE THE WEB GUI TO CONNECT TO THE GATEWAY</b>	<b>26</b>
<b>6 NAVIGATION TREE</b>	<b>29</b>
<b>7 PROCEDURE TO CONFIGURE BACnet Router GW BMS 02-02R</b>	<b>35</b>
<b>8 SNMP FUNCTIONALITY</b>	<b>37</b>
<b>9 CONNECTION DETAILS</b>	<b>38</b>
<b>10 LED INDICATIONS</b>	<b>38</b>

## 1 INTRODUCTION

BMS protocol gateway is a protocol translator between Serial-Serial, Serial-Ethernet devices using MODBUS RTU, MODBUS TCP, BACnet MSTP, BACnet IP, SNMP, Metasys N2, Lonworks protocol. Depending on the model, the gateway has one or two serial ports and one Ethernet port. The Gateway needs to be configured as per engineering details of field equipments to be connected to the gateway.

## 2 SPECIFICATIONS

### Interfaces:

#### Serial Interface

SERIAL PORT: 1

RS-485, 2 Wire, 3 Pin Screw type terminals.

RS-485, 4 Wire, 5 Pin Screw type terminals. (For GW BMS 01 & GW BMS 02)

SERIAL PORT: 2 (Optional depending on the second Protocol selected)

RS-485, 2 Wire, 3 Pin Screw type terminals.

#### LAN

Ethernet : 10/100Mbps – Auto detecting

No. of Ports : 1 Port

Connector : RJ45

### Power Requirements:

Power Input : 24V AC/DC, Range 18V to 30V

Connector : 3 Pin Screw Type

### Environment

Operating Temperature : -40°C to 85°C

Relative Humidity : 5-90% RH, non-condensing

### LED Indications

Indicator Light	State	Introduction
Power	ON	Gateway is Powered ON
	OFF	Gateway is Powered OFF
TX	Blinking	Data Transmission
	OFF	No Data Transmission
Rx	Blinking	Data Reception
	OFF	No Data Reception

### 3 OPERATION

BMS protocol gateway operates for conversion of protocol as per the driver configuration file loaded into it. Depending on driver it can be operated in following modes -

- |  |               |
|--|---------------|
| 1) Modbus RTU (Master/Slave) – BACnet IP (Client/Server)   | GW BMS 01     |
| 2) Modbus RTU (Master/Slave) – BACnet IP (Client/Server)<br>(2- RS 485 ports)  | GW BMS 01-02  |
| 3) BACnet MSTP (Master/Slave) – BACnet IP (Client/Server)  | GW BMS 02     |
| 4) BACnet MSTP (Master/Slave) – BACnet IP (Client/Server)-Router<br>(2-RS 485 ports)   | GW BMS 02 02R |
| 5) Lonworks (Master/Slave) – BACnet IP(Client/Server)  | GW BMS 03     |
| 6) Modbus RTU (Master/Slave) - Metasys N2 (Client/Server)<br>BACnet MSTP (Master/Slave) - Metasys N2(Client/Server)<br>Metasys N2 (Master/Slave) – BACnet IP (Client/Server) | GW BMS 04     |
| 7) SNMP (Client/Server) to BACnet IP(Client/Server)<br>SNMP (Client/Server) to Modbus TCP<br>BACnet IP to Modbus TCP<br>Ethernet IP to Modbus RTU/Modbus TCP                 | GW BMS 05     |

### 4 REMOTE USER INTERFACE

The Ruinet Utility is used to:

- Transfer files (configuration, firmware, etc) to and from a Gateway.
- Monitor a working Gateway's internal data and parameters.
- Change the Gateway IP address.
- Restart the gateway.

- **4.1 Installing and setup**

The Utility is provided in CD shipped with the gateway. It can be accessed from 'Manual & Utility' folder. (Manual & Utility/BMS Gateway/Utility).

Also Ruinet can be downloaded from below link.

<http://www.santelequip.com/download/BMS%20gateway/Ruinet/>

#### Factory Default Setting

The gateway is set with following default settings.

IP Address	Subnet Mask	Gateway	DHCP Client
192.168.1.200	255.255.255.0	Disabled	Disabled

#### 4.2 A - Connecting to the gateway

To discover the gateway on RUINET utility following procedure is used

- 1 Connect the ethernet straight cable between gateway and PC.
- 2 Gateway is assigned default IP address as 192.168.1.200. Please set the IP address to PC that is compliant with subnet of gateway's subnet mask (192.168.1.xx) and does not clash with gateway's IP address.
- 3 Power on the gateway using 24 V AC/DC supplies. Open the Ruinet.exe file. It will show the IP address after discovering the gateway in approximately 1 minute.

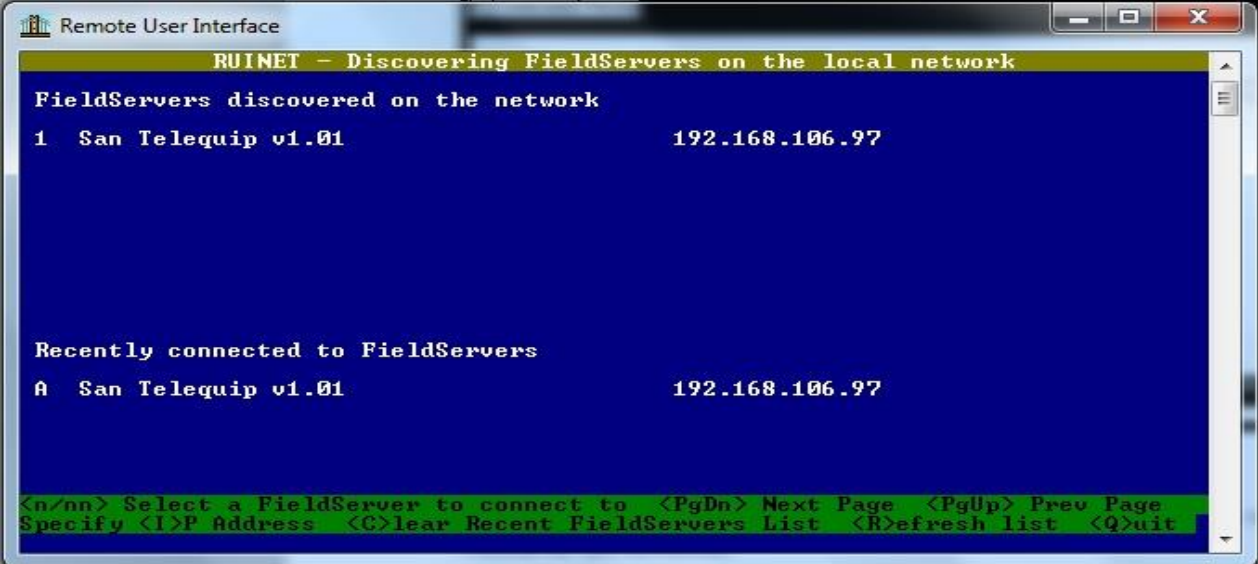

```
Remote User Interface
RUINET - Discovering FieldServers on the local network
FieldServers discovered on the network
1 San Telequip v1.01          192.168.106.97

Recently connected to FieldServers
A San Telequip v1.01          192.168.106.97

<n/nn> Select a FieldServer to connect to <PgDn> Next Page <PgUp> Prev Page
Specify <I>P Address <C>lear Recent FieldServers List <R>efresh list <Q>uit
```

- 4 Press "1" key to go to the 'Main menu' details.

San Telequip (P) Ltd.,  
 504 & 505, Deron heights, Opp Mahabaleshwar hotel  
 Baner Road, Baner Pune 411 045  
 Phone : 020-, 65001587  
 email : [info@santelequip.com](mailto:info@santelequip.com)

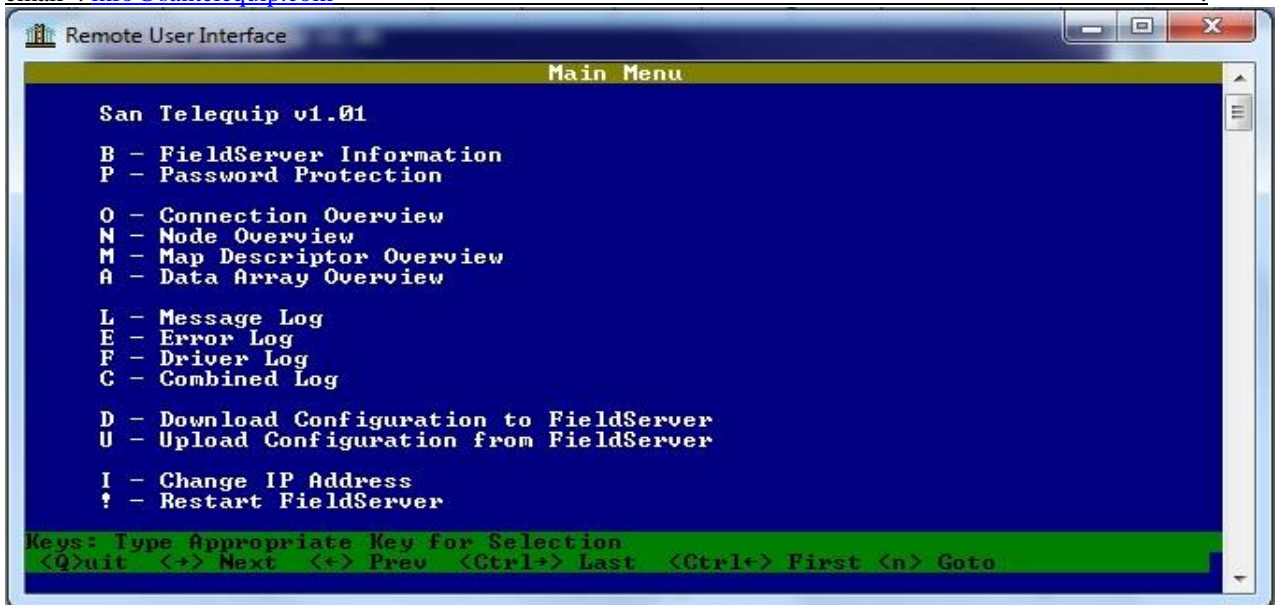

In the Main Menu Section following options are available to select:

### 4.3 B- Fieldserver Information

Press "B" key to access the screen displaying general information about the gateway.

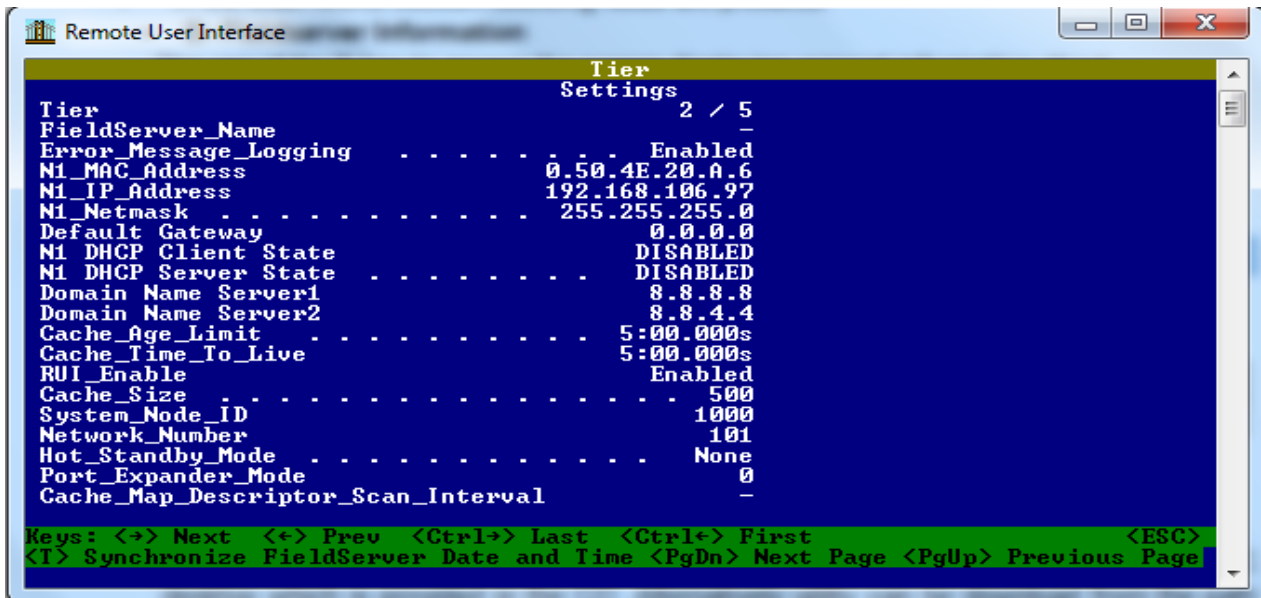

### 4.4 P- Enable/Disable Password Protection

This screen allows the administrator to restrict access to data and the ability to make changes. Password protection is disabled by default.

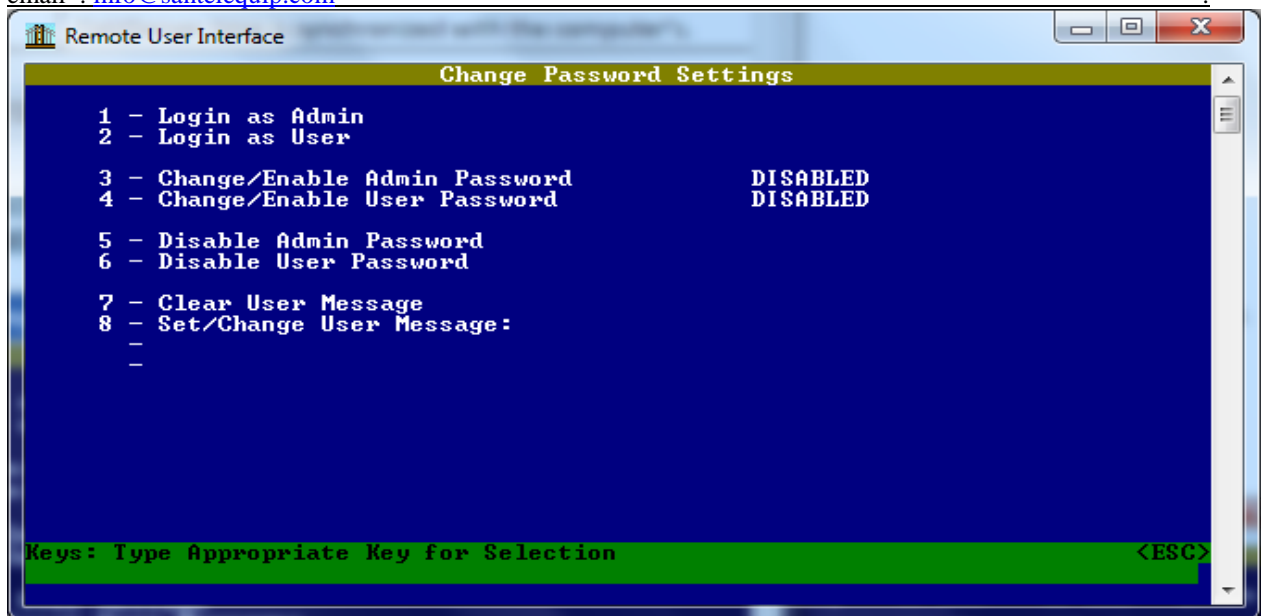

Following table shows the description of parameters.

Parameter	Description
Login as Admin	Admin privileges allow full access to all screens and changes to information.
Login as User	User privileges allow read only access, i.e. browsing between screens, but no changes can be made.
Change/Enable Admin Password	Administrator password enabled – protects access. Once the protection is enabled, “Password Screen” (Figure 1) will be the only screen visible until logged in as User or Admin using options ‘1’ or ‘2’
Change/Enable User password	Administrator can create user account.
Disable Admin Password	Protection removed by administrator
Disable User Password	Remove the User Account

#### 4.5 O-Connection Overview

Press ‘O’ key to enter in this menu. This screen supplies information on communication between the gateway and remote devices.

San Telequip (P) Ltd.,  
 504 & 505, Deron heights, Opp Mahabaleshwar hotel  
 Baner Road, Baner Pune 411 045  
 Phone : 020-, 65001587  
 email : [info@santelequip.com](mailto:info@santelequip.com)

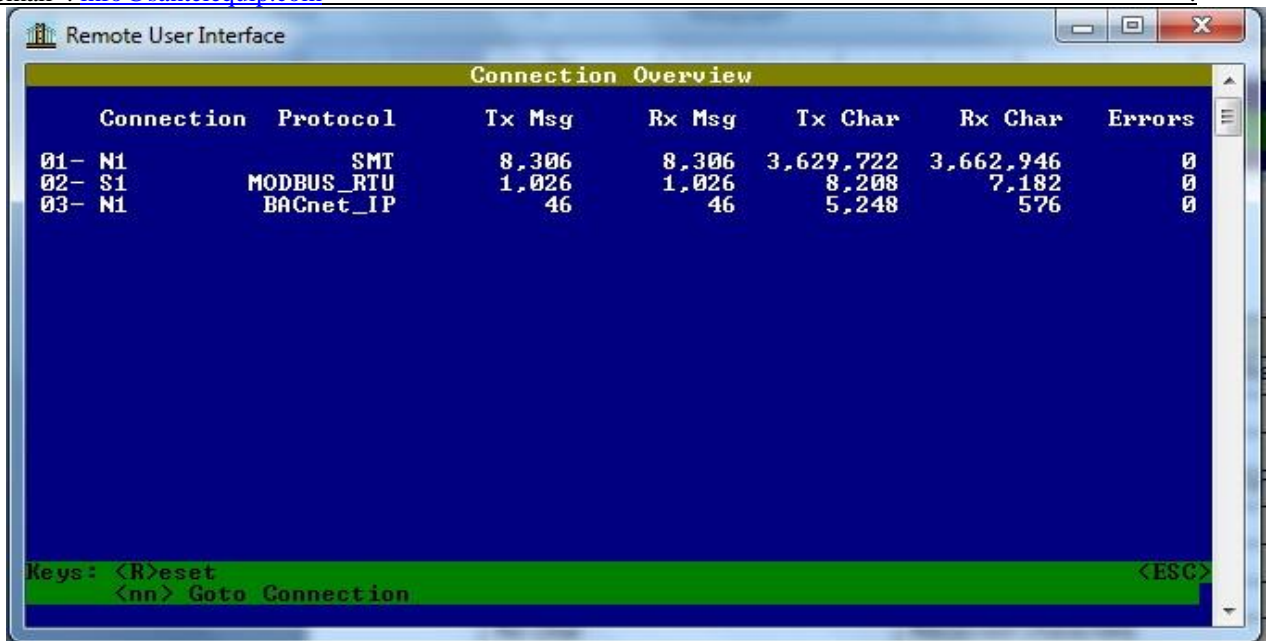

Following table shows the description of parameters.

Parameter	Description
Connection	The current connection out of the total number of connections.
	N1-Network Adapter
N1,S1,N1	Port/Adapter
Protocol	Protocol specified as per the Port/Adapter
Tx Msg	Transmitted Messages
Rx Msg	Received Messages
Tx Char	Transmitted Characters
Rx Char	Received Characters
Errors	Displays the number of errors for each connection. Occasional errors may indicate noise but may also indicate a systematic error.

#### 4.6 N-Node Overview

Press 'N' key to enter in Node Overview menu.



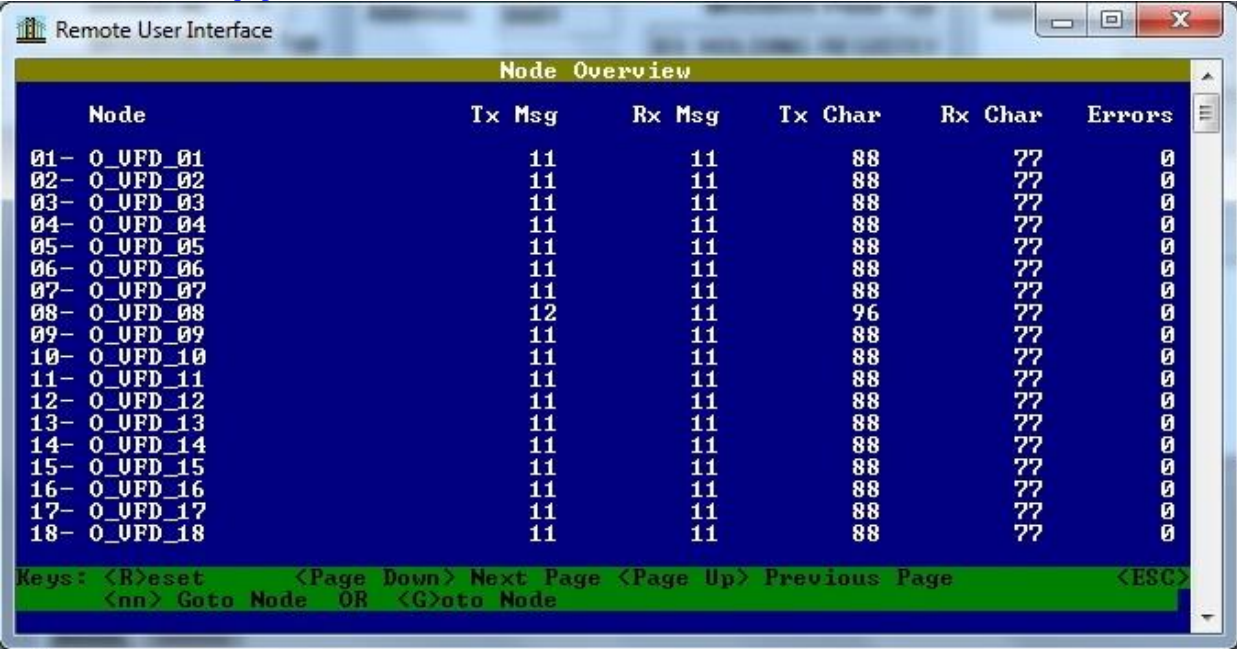

Remote User Interface

Node	Tx Msg	Rx Msg	Tx Char	Rx Char	Errors
01- 0_UFD_01	11	11	88	77	0
02- 0_UFD_02	11	11	88	77	0
03- 0_UFD_03	11	11	88	77	0
04- 0_UFD_04	11	11	88	77	0
05- 0_UFD_05	11	11	88	77	0
06- 0_UFD_06	11	11	88	77	0
07- 0_UFD_07	11	11	88	77	0
08- 0_UFD_08	12	11	96	77	0
09- 0_UFD_09	11	11	88	77	0
10- 0_UFD_10	11	11	88	77	0
11- 0_UFD_11	11	11	88	77	0
12- 0_UFD_12	11	11	88	77	0
13- 0_UFD_13	11	11	88	77	0
14- 0_UFD_14	11	11	88	77	0
15- 0_UFD_15	11	11	88	77	0
16- 0_UFD_16	11	11	88	77	0
17- 0_UFD_17	11	11	88	77	0
18- 0_UFD_18	11	11	88	77	0

Keys: <R>reset    <Page Down> Next Page    <Page Up> Previous Page    <ESC>  
 <nn> Goto Node    OR    <G>oto Node

Following table shows the description of each parameter.

Parameter	Description
Node	Shows the number of nodes with names configured in configuration file
Tx Msg	Transmitted Messages at specified node
Rx Msg	Received Messages at specified node
Tx Char	Transmitted Characters at specified node
Rx Char	Received Characters at specified node
Errors	Displays the number of errors for each node. Occasional errors may indicate noise but may also indicate a systematic error.

#### 4.7 M-Map Descriptor Overview

Press 'M' in main menu to enter Map descriptor Overview.

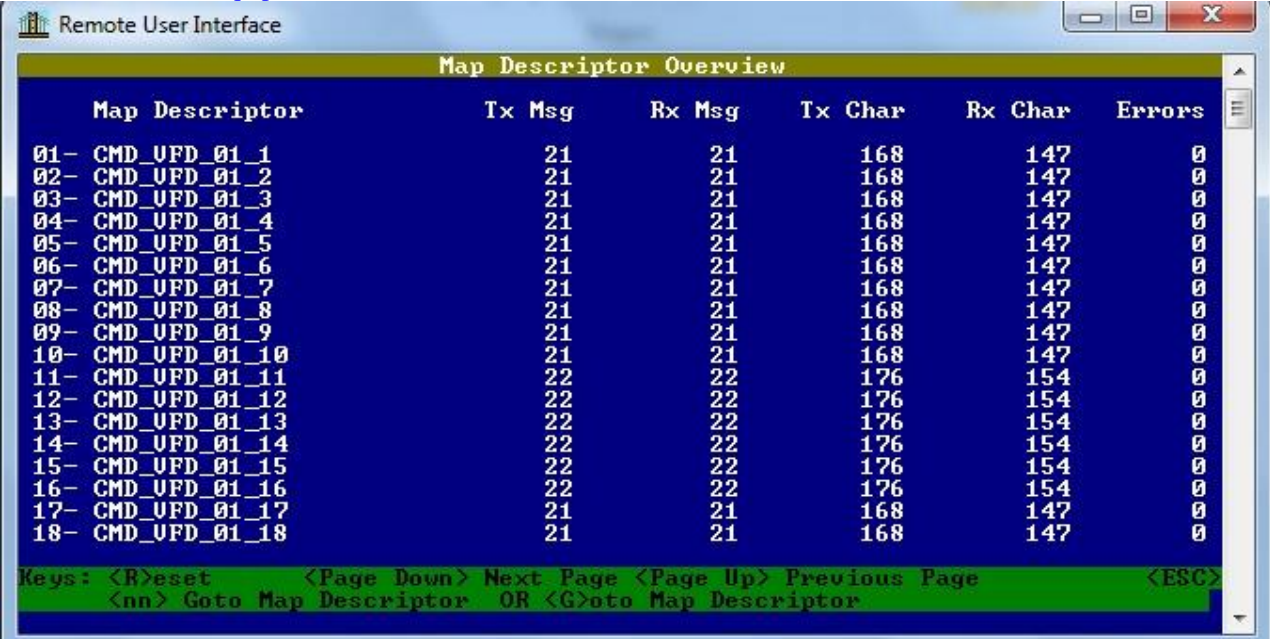

The screenshot shows a window titled 'Remote User Interface' with a sub-header 'Map Descriptor Overview'. It displays a table with 6 columns: Map Descriptor, Tx Msg, Rx Msg, Tx Char, Rx Char, and Errors. The data rows show 18 map descriptors (01-18) with varying Tx and Rx counts and zero errors. A green key legend at the bottom explains navigation controls like <R>reset, <Page Down> Next Page, <Page Up> Previous Page, <ESC>, <nn> Goto Map Descriptor, and <G>oto Map Descriptor.

Map Descriptor	Tx Msg	Rx Msg	Tx Char	Rx Char	Errors
01- CMD_UFD_01_1	21	21	168	147	0
02- CMD_UFD_01_2	21	21	168	147	0
03- CMD_UFD_01_3	21	21	168	147	0
04- CMD_UFD_01_4	21	21	168	147	0
05- CMD_UFD_01_5	21	21	168	147	0
06- CMD_UFD_01_6	21	21	168	147	0
07- CMD_UFD_01_7	21	21	168	147	0
08- CMD_UFD_01_8	21	21	168	147	0
09- CMD_UFD_01_9	21	21	168	147	0
10- CMD_UFD_01_10	21	21	168	147	0
11- CMD_UFD_01_11	22	22	176	154	0
12- CMD_UFD_01_12	22	22	176	154	0
13- CMD_UFD_01_13	22	22	176	154	0
14- CMD_UFD_01_14	22	22	176	154	0
15- CMD_UFD_01_15	22	22	176	154	0
16- CMD_UFD_01_16	22	22	176	154	0
17- CMD_UFD_01_17	21	21	168	147	0
18- CMD_UFD_01_18	21	21	168	147	0

Following table shows the description of each parameter.

Parameter	Description
Map Descriptor	Shows the all map descriptor names configured in configuration file.
Tx Msg	Transmitted Messages by the specified Map descriptor
Rx Msg	Received Messages by the specified Map descriptor
Tx Char	Transmitted Characters by the specified Map descriptor
Rx Char	Received Characters by the specified Map descriptor
Errors	Displays the number of errors for each Map descriptor. Occasional errors may indicate noise but may also indicate a systematic error.

#### 4.8 A-Data Array Overview

Press key 'A' in the main menu to enter into Data Array Overview

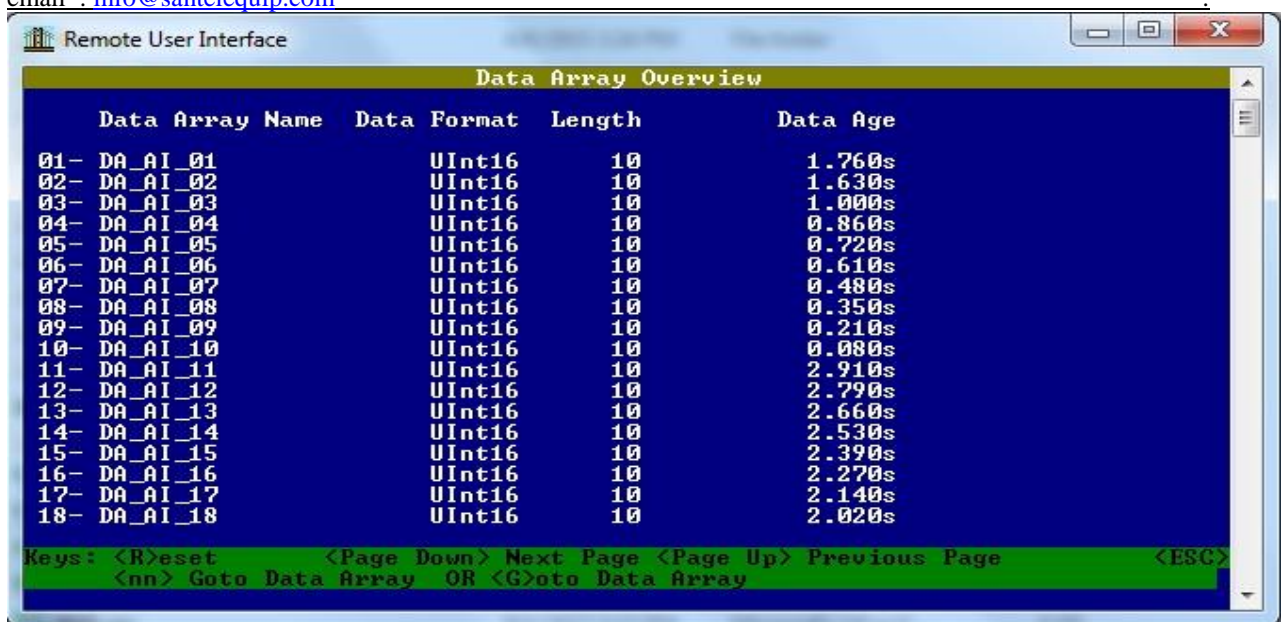

Following table shows the description of each parameter

Parameter	Description
Data Array Name	Shows the all data arrays names configured in configuration file.
Data Array Format	Format used when accessing data in the Data Array
Length	Number of elements in the Data Array.
Data Age	Time elapsed since any element of array was last updated

To check the data in a data array press the number displays before the data array name.  
 e.g. To data from data array name 'DA\_AI\_01' press 01 in data array overview menu.

#### 4.9 L - Message Log

Press "L" in Main Menu to enter 'Message Log' menu. Following window will be open.  
 This screen shows normal informational type messages from the operating system.

San Telequip (P) Ltd.,  
504 & 505, Deron heights, Opp Mahabaleshwar hotel  
Baner Road, Baner Pune 411 045  
Phone : 020-, 65001587  
email : [info@santelequip.com](mailto:info@santelequip.com)



Remote User Interface

Message Log

```
02/27 18:57 MEM_API -> 112,208 kB System Memory Free
02/27 18:57 MEM_API -> 100,987 kB Application Memory
--/-- --:-- Init Carrier: Legacy Carrier
--/-- --:-- REGAPI-> Registry Update Done
--/-- --:-- Processing config.csv
--/-- --:-- REGAPI-> Config revision update<21>
--/-- --:-- Loaded config.csv in 1 seconds
--/-- --:-- REGAPI-> Registry Update Done
--/-- --:-- API-> SLOT_API : Max data points set to 1500
--/-- --:-- SYSTEM -> Clock remotely set to Sat Feb 27 18:57:44 2016
--/-- --:-- SYSTEM -> Estimated startup time Sat Feb 27 18:57:34 2016
```

Keys: <R>reset Display <U>ersions <ESC>  
<Page Down> Next Page <Page Up> Previous Page

#### 4.10 E - Error Log

Press 'E' in Main Menu to enter in Error Log menu. Following window will be Open and it will show error messages.

Remote User Interface

Error Log

```
--/-- --:-- This section of buffer [DA_AI_01], starting [80] length [2]
--/-- --:-- Already has responsible mapdesc
--/-- --:-- Configuration File Error -----
--/-- --:-- Desc : Data Object already has responsible Read Map Descriptor
--/-- --:-- Error: -1053
--/-- --:-- File : config.csv, line 188
--/-- --:-- Line : CMD_EM_01_41,DA_AI_01 ,80, Rdbc ,U_EM_01,30117,2,
1.000s,...
```

Keys: <R>reset Display <U>ersion <ESC>  
<Page Down> Next Page <Page Up> Previous Page

If errors are not present then in window, 'No Errors' message will be displayed.

San Telequip (P) Ltd.,  
504 & 505, Deron heights, Opp Mahabaleshwar hotel  
Baner Road, Baner Pune 411 045  
Phone : 020-, 65001587  
email : [info@santelequip.com](mailto:info@santelequip.com)

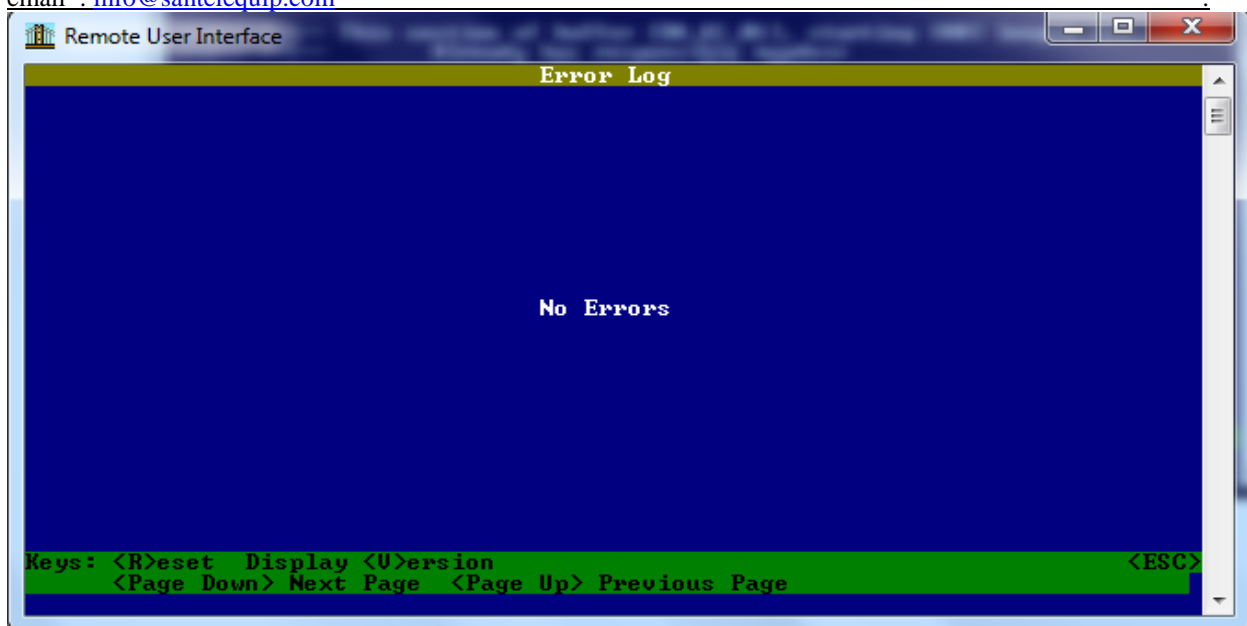

#### 4.11 F - Driver Log

Press 'F' key into Main Menu to enter in Driver Log menu. Informational type messages from protocol drivers, e.g. Modbus is printed on this screen. If there is no any Driver messages 'No Messages' will be displayed on the screen.

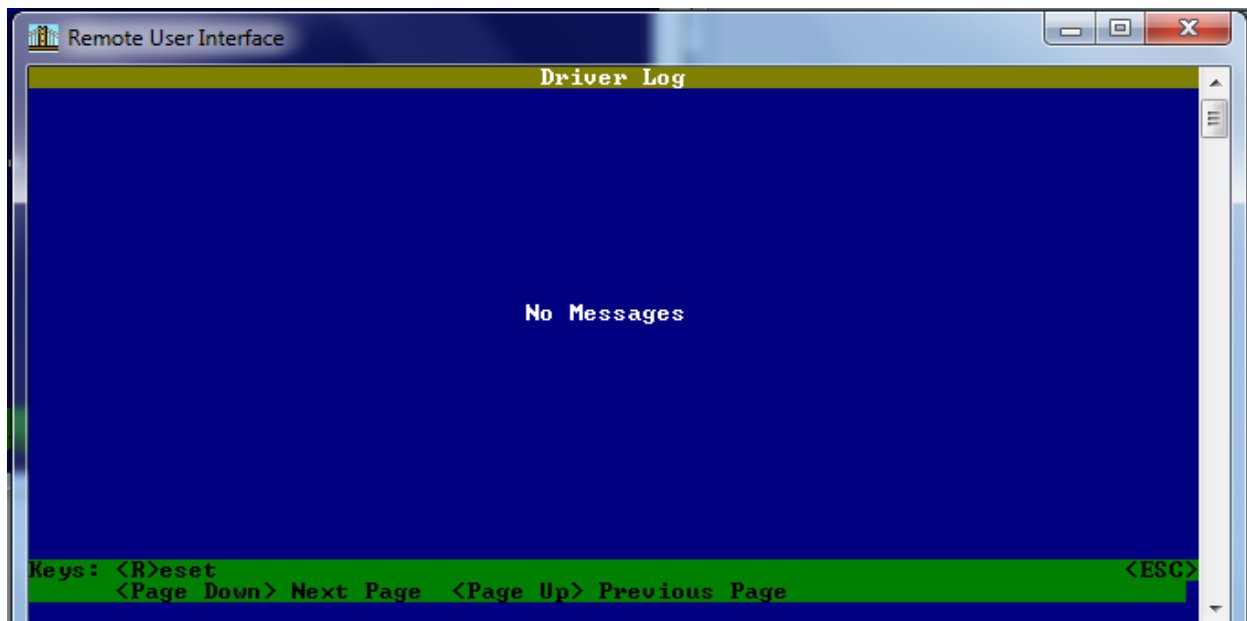

#### 4.12 C - Combined Log

San Telequip (P) Ltd.,  
504 & 505, Deron heights, Opp Mahabaleshwar hotel  
Baner Road, Baner Pune 411 045  
Phone : 020-, 65001587  
email : [info@santelequip.com](mailto:info@santelequip.com)



Press 'C' key into Main Menu to enter in the Combined Log menu.  
All messages from the E, F and L screens are displayed on this screen.

A screenshot of a 'Remote User Interface' window. The window title is 'Remote User Interface' and it has standard Windows window controls (minimize, maximize, close). The main content area has a dark blue background with white text. At the top, a yellow header bar contains the text 'Combined Log'. Below this, the log output shows system memory status, registry updates, and configuration changes. At the bottom, a green bar contains navigation keys: '<R>reset', '<D>isplay', '<U>ersions', '<ESC>', '<Page Down> Next Page', and '<Page Up> Previous Page'.

```
02/27 19:13 MEM_API -> 112,208 kB System Memory Free
02/27 19:13 MEM_API -> 100,987 kB Application Memory
---/--- ---:--- Init Carrier: Legacy Carrier
---/--- ---:--- REGAPI-> Registry Update Done
---/--- ---:--- Processing config.csv
---/--- ---:--- REGAPI-> Config revision update<24>
---/--- ---:--- Loaded config.csv in 1 seconds
---/--- ---:--- REGAPI-> Registry Update Done
---/--- ---:--- API-> SLOT_API : Max data points set to 1500
---/--- ---:--- SYSTEM -> Clock remotely set to Sat Feb 27 19:13:56 2016
---/--- ---:--- SYSTEM -> Estimated startup time Sat Feb 27 19:13:44 2016

Keys: <R>reset  <D>isplay  <U>ersions  <ESC>
      <Page Down> Next Page  <Page Up> Previous Page
```

#### 4.13 D - Download configuration

- 1) For preparing configuration file technical details like baud rate settings, slave device IDs, modbus mapping should be given to the Santelequip. After obtaining CSV file from Santelequip, copy the file onto the computer drive.
- 2) Make sure that the gateway is discovered on the network and basic menu is visible in utility. If not, assign correct IP address to the gateway and bring the gateway on network. After discovery, the utility screen will look like below.

San Telequip (P) Ltd.,  
504 & 505, Deron heights, Opp Mahabaleshwar hotel  
Baner Road, Baner Pune 411 045  
Phone : 020-, 65001587  
email : [info@santelequip.com](mailto:info@santelequip.com)

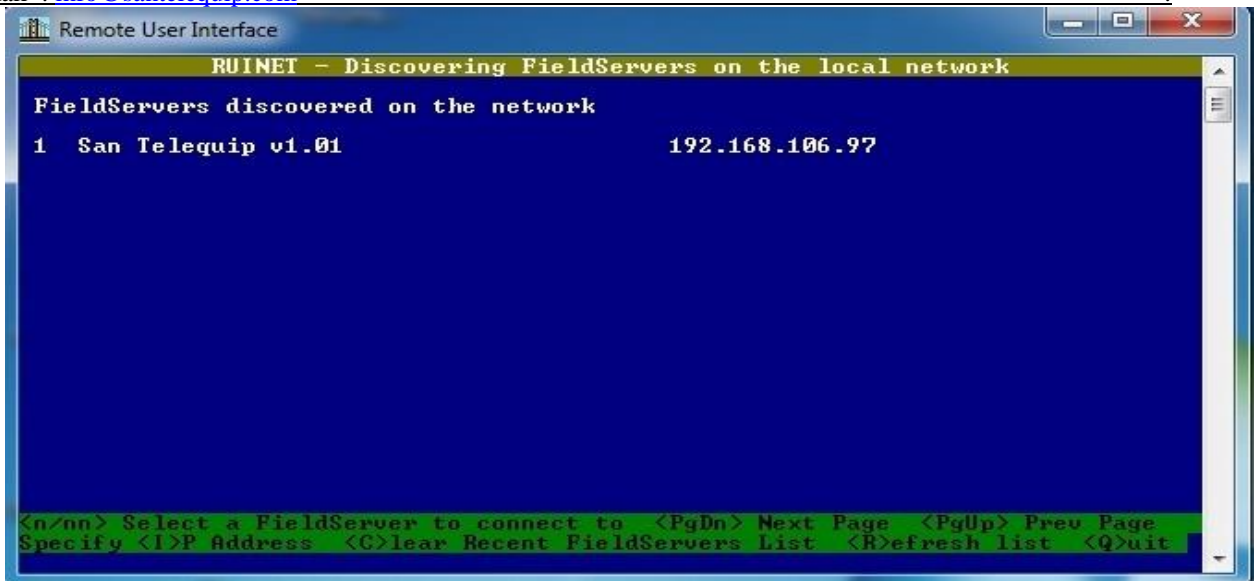

3) Press '1' key to enter into the main menu details.

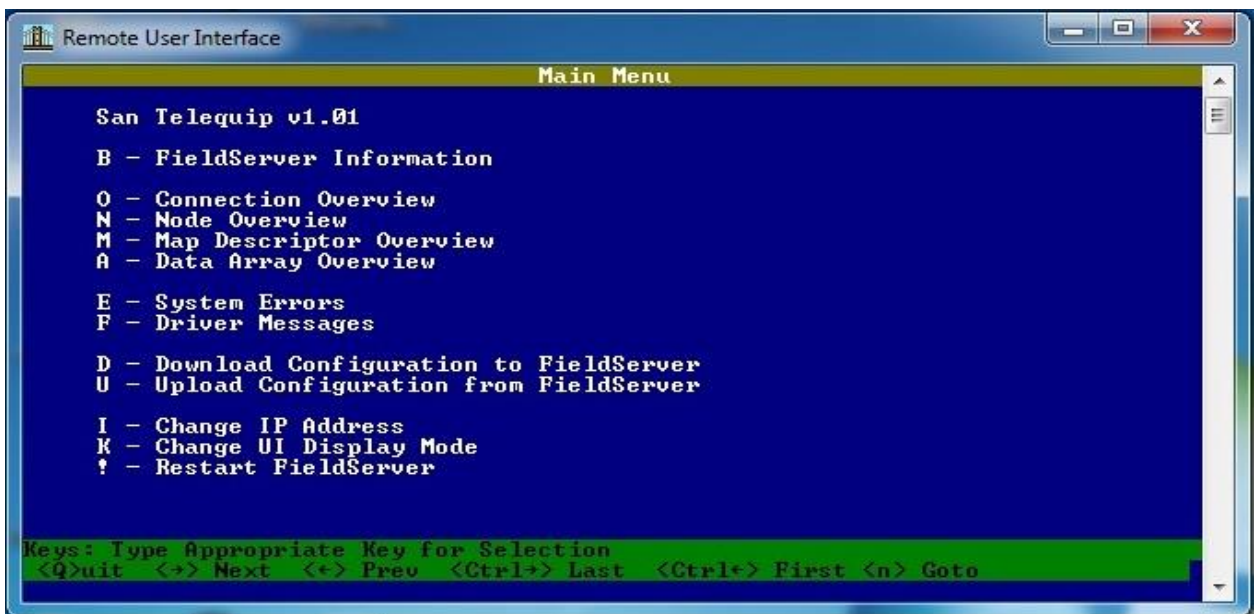

4) Press 'D' key to go to the download screen.

San Telequip (P) Ltd.,  
504 & 505, Deron heights, Opp Mahabaleshwar hotel  
Baner Road, Baner Pune 411 045  
Phone : 020-, 65001587  
email : [info@santelequip.com](mailto:info@santelequip.com)



- 5) Press 'L' to specify the configuration file name. Enter the name of the file with its drive path on the computer and press enter.

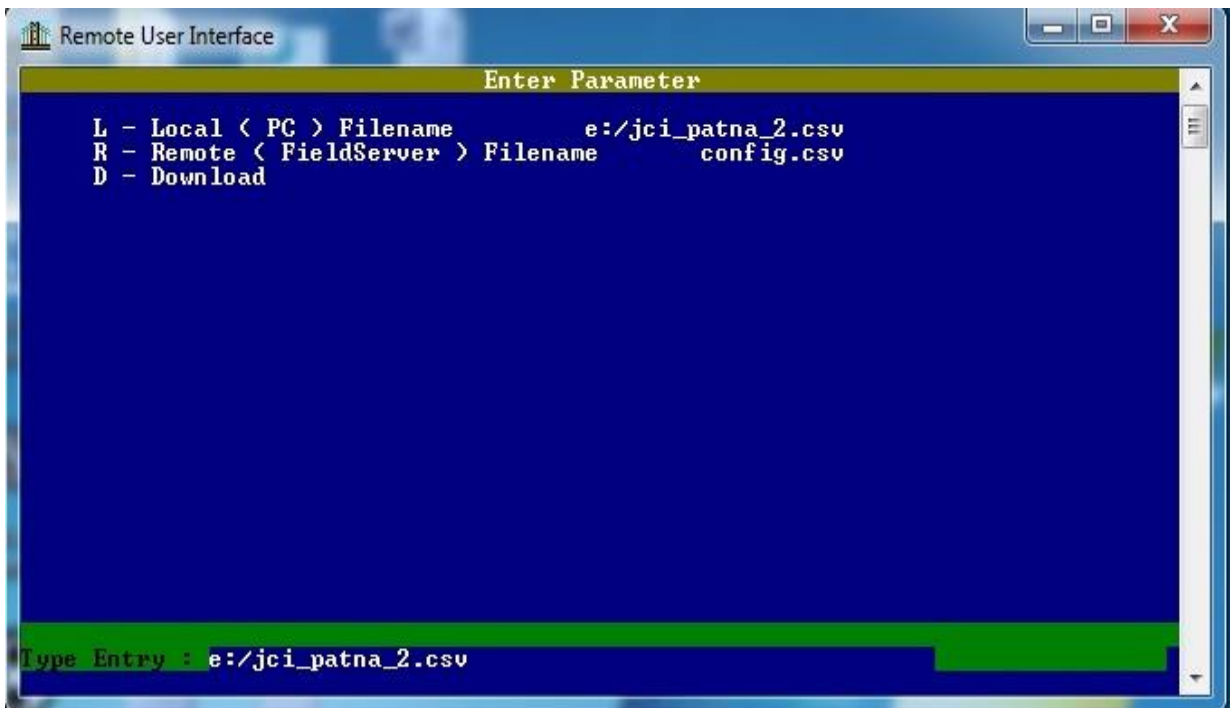

- 6) Begin the download by selecting 'D' and wait till download is completed. 'Download Complete' message is shown on screen.



- 7) Press Escape key twice to go back to the main menu and restart the BMS gateway by pressing '!' (Shift+1) key.
- 8) Wait till gateway gets restarted.

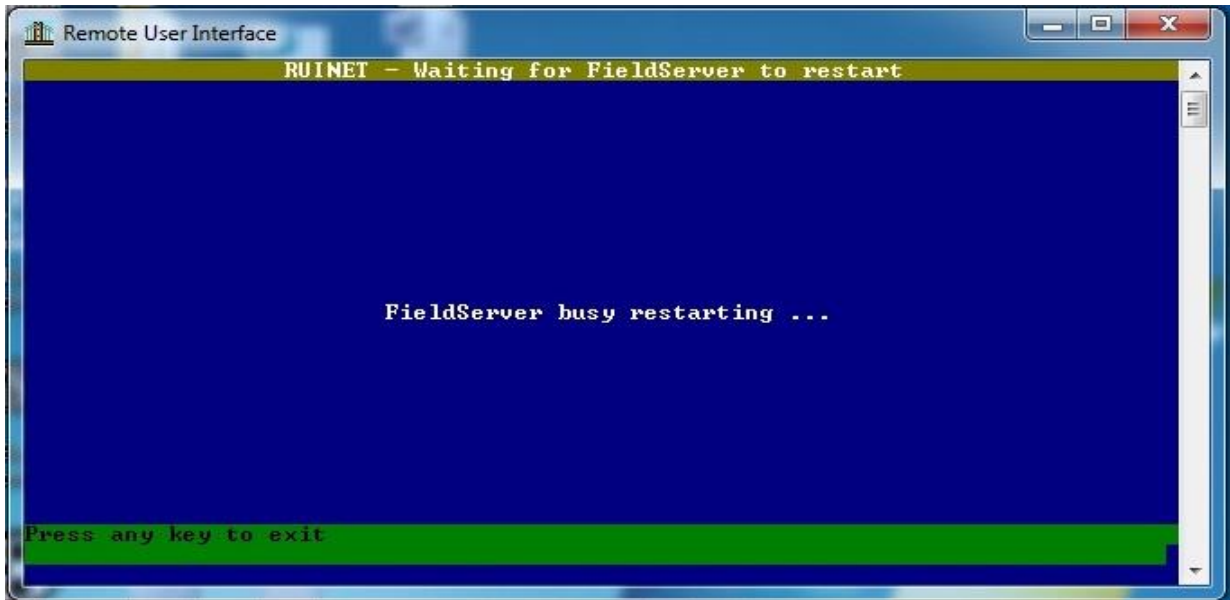

- 9) Close the Ruinet.exe file after detecting the IP address of the gateway in the Ruinet. This completes the download procedure of the configuration file into the BMS gateway.

The gateway is now ready with its drivers for field installation. Connect the required client / server side cables and check whether the driver information mapping is correctly observed on either side.

#### 4.14 U - Upload configuration

1) Press 'U' key into Main Menu following window will open.

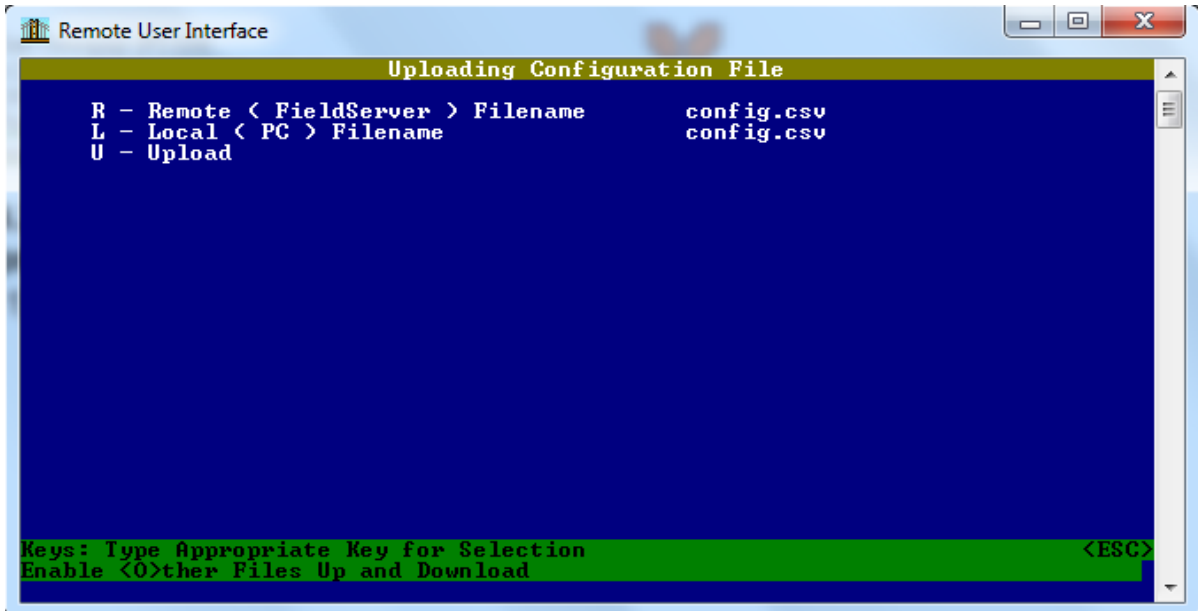

2) Press 'L' for Local (PC) filename. Then type the local drive path and file name with ".csv" extension (Please see below snapshot) and press enter key.

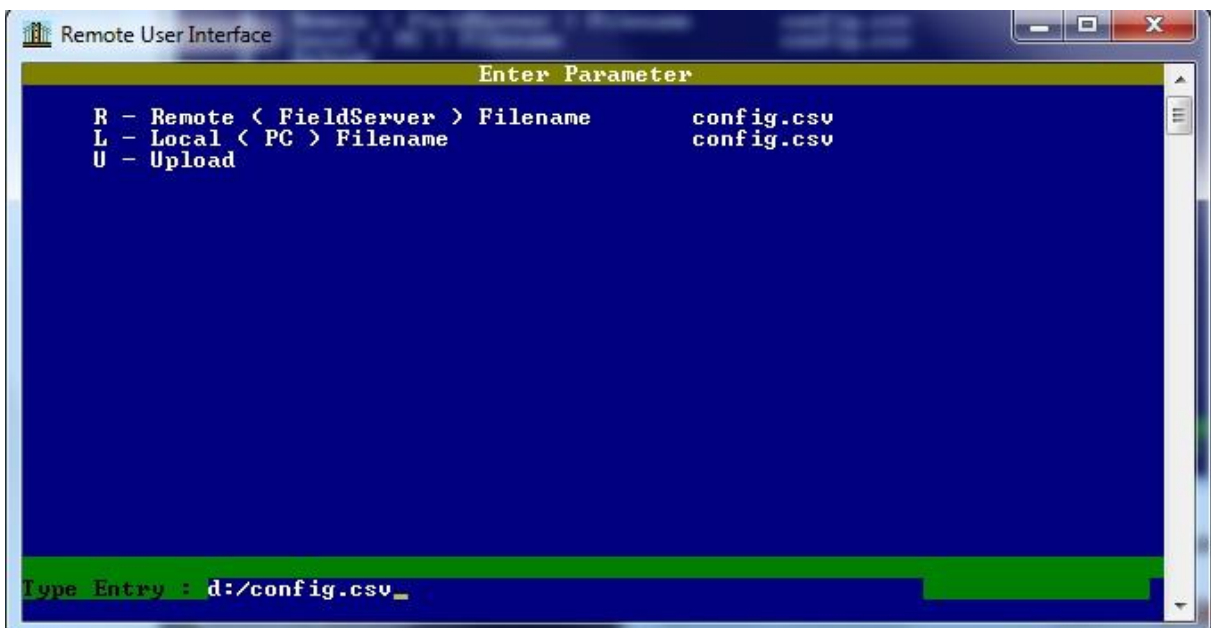

- 3) Begin the upload by selecting 'U' key and wait till upload is completed. 'Transfer Complete' message will be shown on screen.

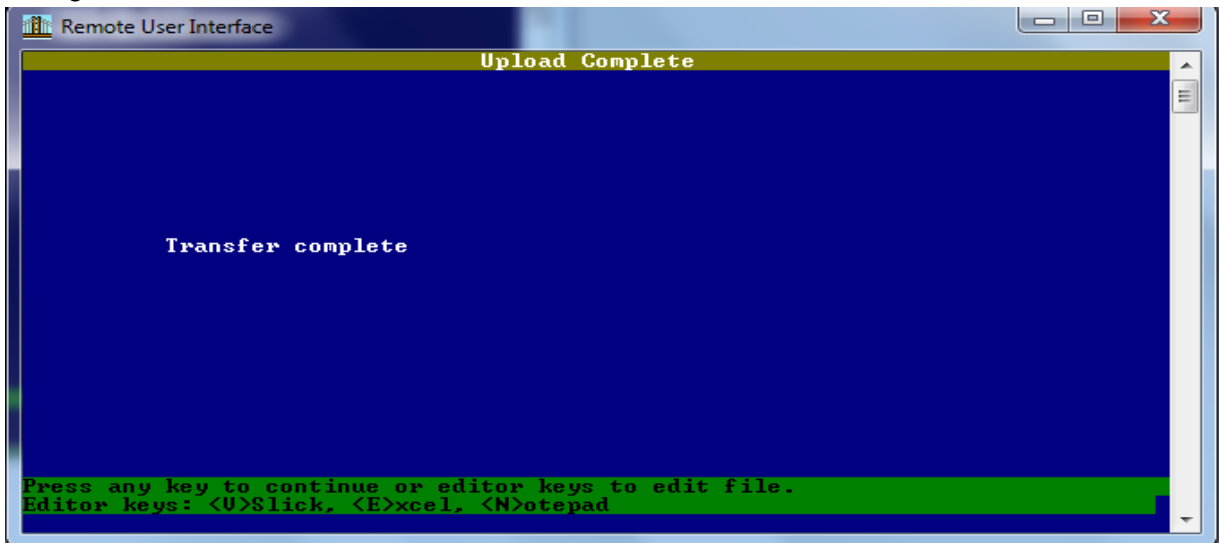

- 4) Press 'Esc' key to go back into main menu. File is saved at given specific drive in the PC.

#### 4.15.1 I – Change IP Address

1) Gateway is assigned default IP address as 192.168.1.200. Please set the IP address to PC that is compliant with subnet of gateway's subnet mask and does not clash with gateway's IP address.

E.g. Gateway IP address is 192.168.1.200 Subnet mask: 255.255.255.0 then assigns any IP address to PC as 192.168.1.xx.

- 2) Press 'I' key into the Main Menu.

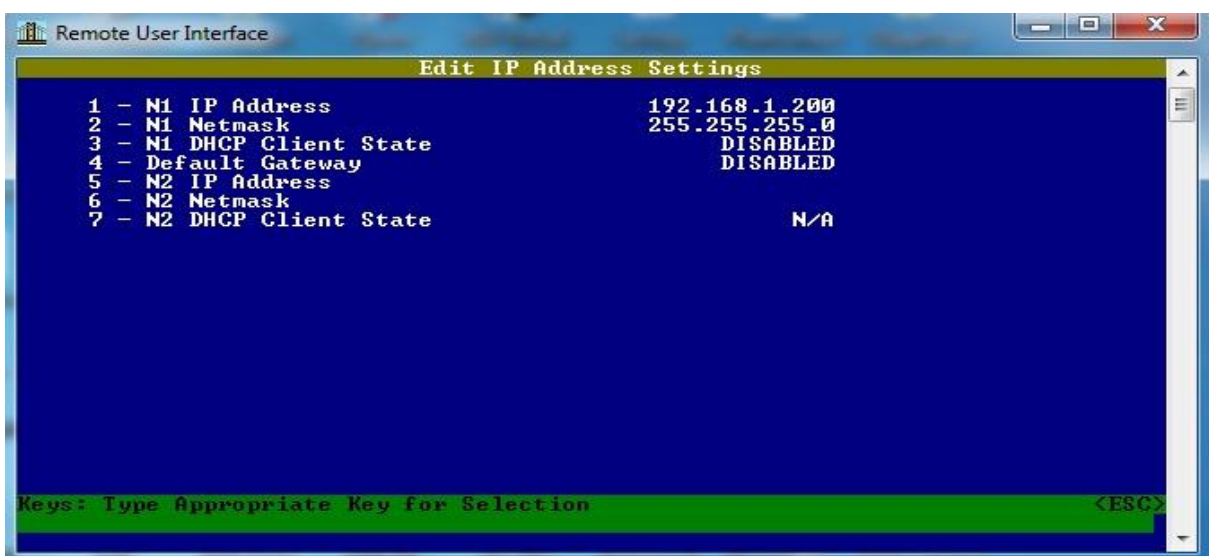

3) Press "1" key to enter the new IP address. After pressing '1', Type entry menu will be displayed at the bottom of the window. Type the new IP address and press enter.

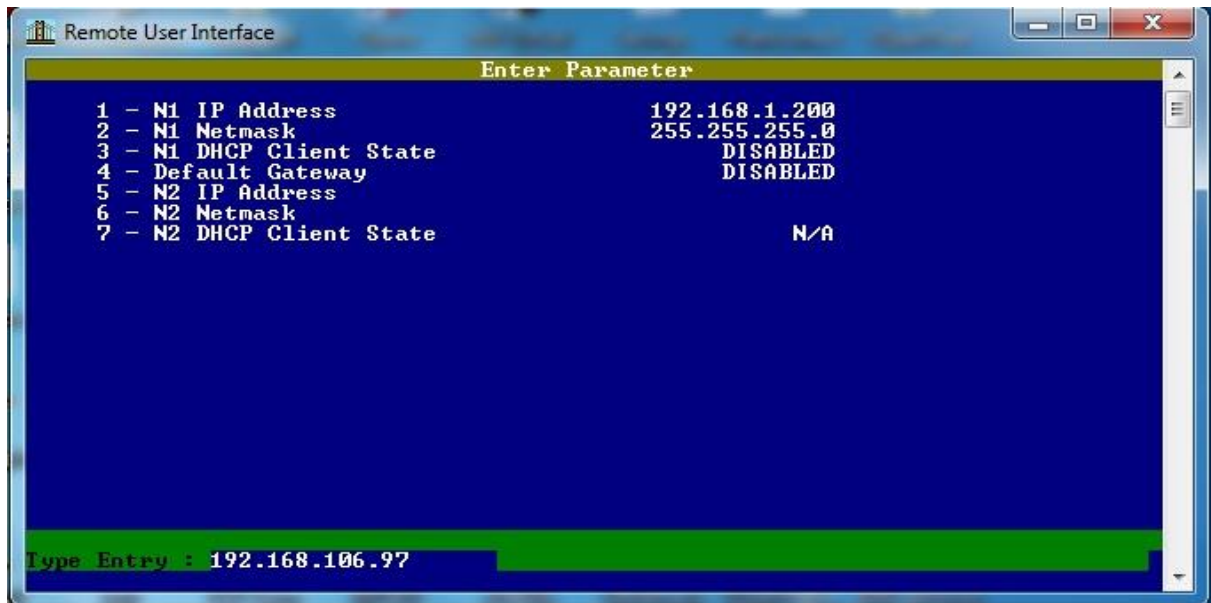

4) After pressing "ENTER" following window will be displayed.

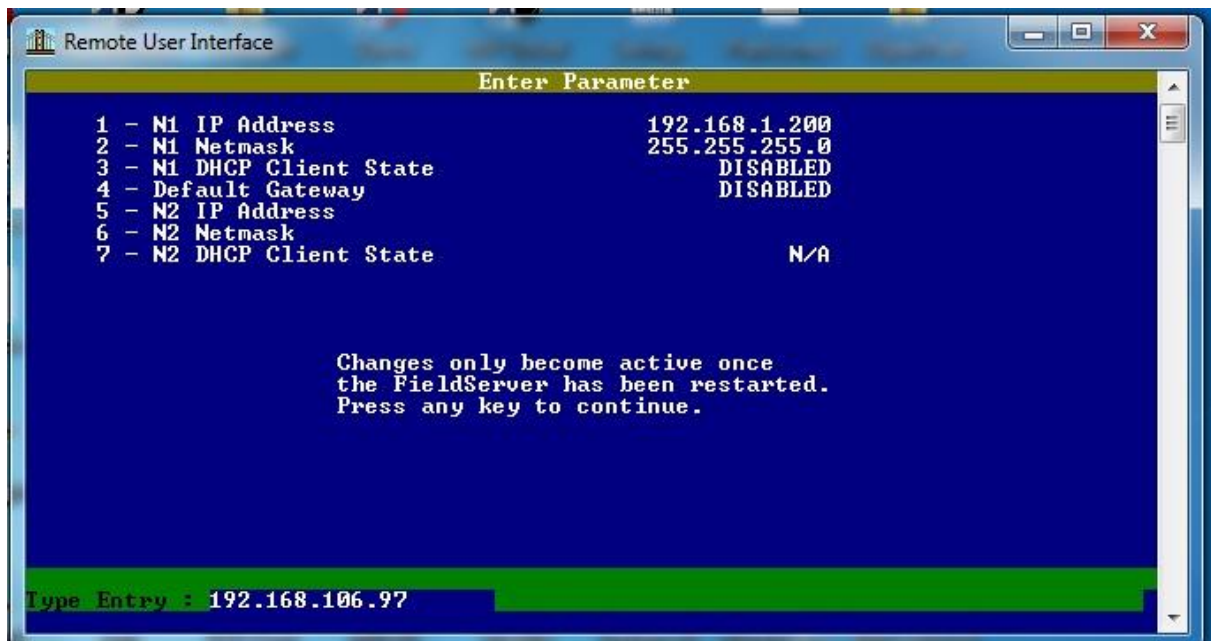

5) Press any key. New IP address will be shown in the IP Address settings as below.

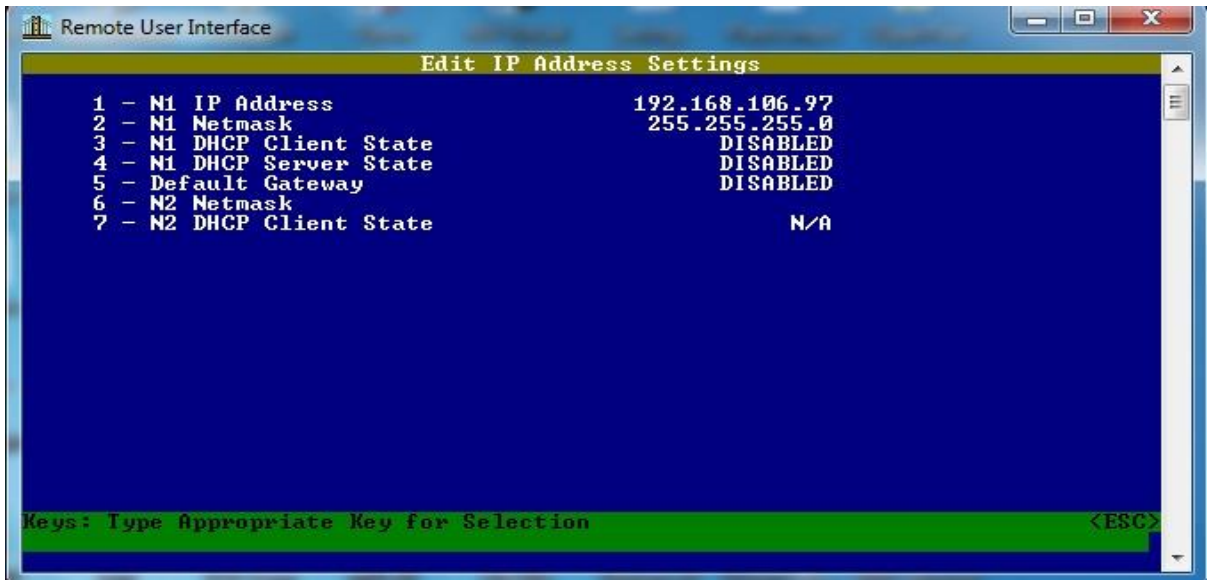

6) For new IP to take effect it is necessary to restart the gateway from main menu. Go to main menu by pressing "ESC" key twice. The main menu will be displayed as follows.

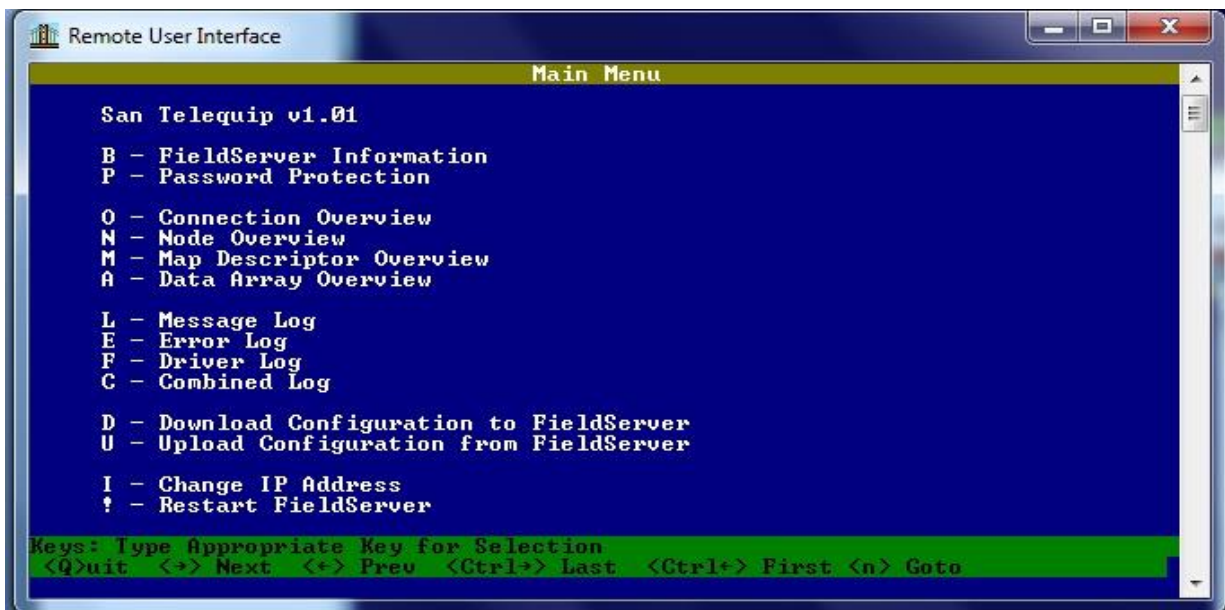

San Telequip (P) Ltd.,  
504 & 505, Deron heights, Opp Mahabaleshwar hotel  
Baner Road, Baner Pune 411 045  
Phone : 020-, 65001587  
email : [info@santelequip.com](mailto:info@santelequip.com)



7) Now restart the unit using ! (Shift+1) key. Following window will be displayed.



8) Change the laptop IP address as compliant with new IP address of the gateway. The gateway IP above was set as 192.168.106.97, so PC IP should be set as 192.168.106.xx.

9) Close the ruinet utility and open it again. New IP address will be shown on the ruinet as below.

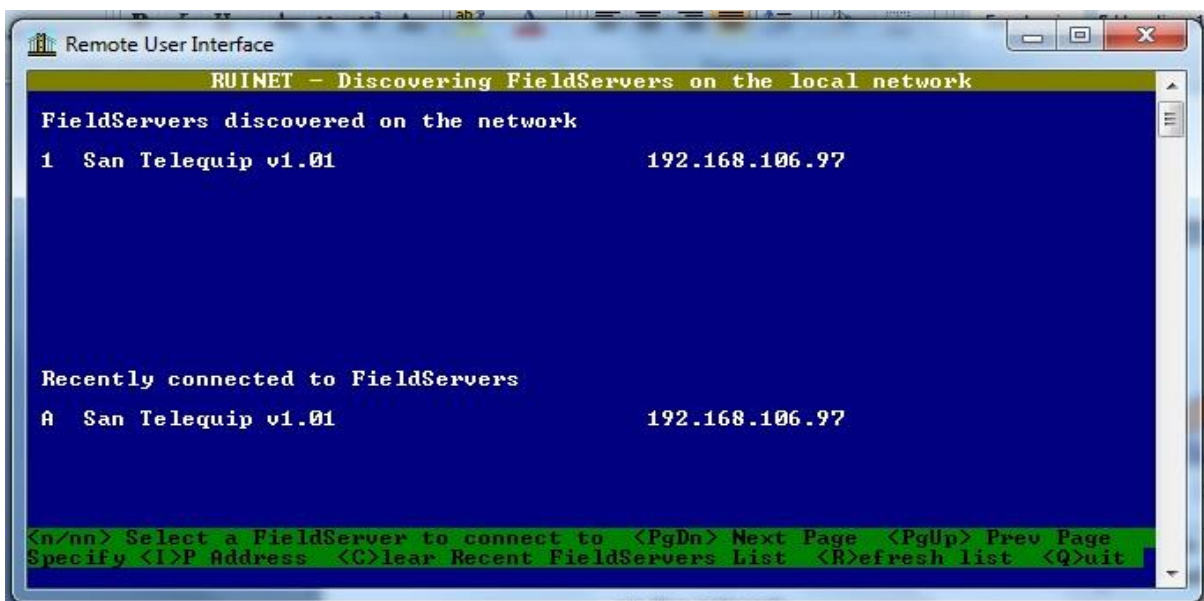

#### 4.15.2 Obtain IP address using DHCP client

The gateway can obtain its IP address from a DHCP Server using the built-in DHCP Client. The network's DHCP Server must be setup correctly for this to work. Please contact your network administrator for assistance.

- i) Enable the DHCP Client on Ethernet port N1 and/or N2 by pressing "4".
- ii) Press "Y" <Enter>. "N" will disable the DHCP client.

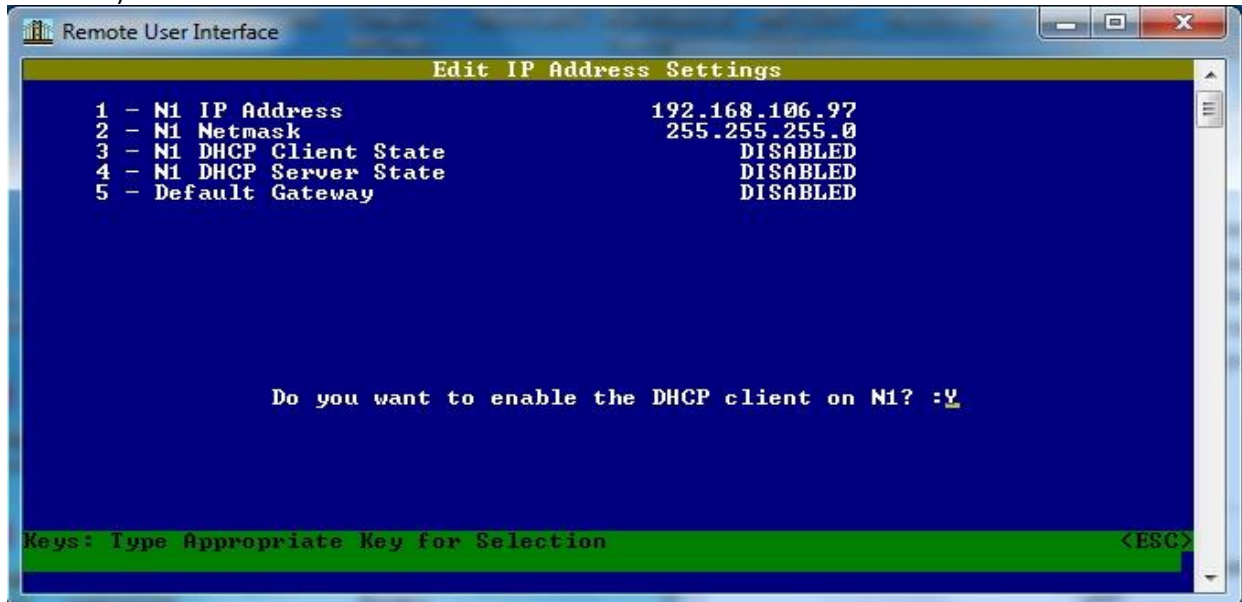

- iii) Press any key to continue and escape back to the main menu. Press "!" to restart the gateway
- iv) Press "Q" twice to quit from Ruinet and the discovery screen.
- v) Run Ruinet again to connect to the gateway.

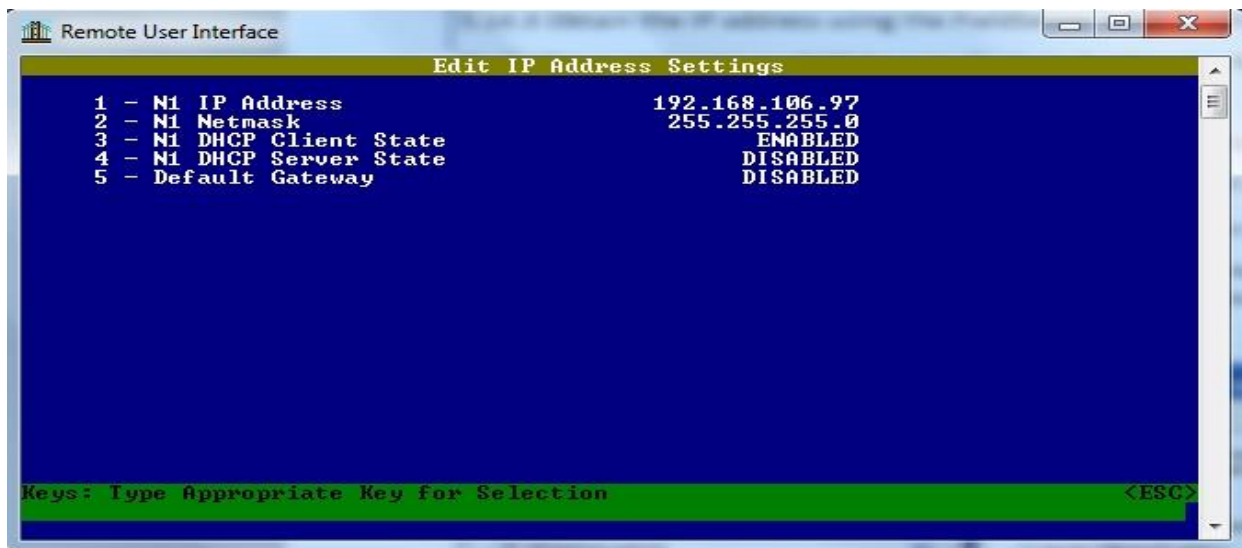

If the gateway cannot contact a DHCP Server, the gateway will use the last good IP address it was configured with.

#### 4.15.3 Obtain IP address to the PC or laptop using DHCP server

The gateway can be used as a DHCP Server to allocate an IP address to a PC or Laptop that you want to use to connect with Ruinet to the gateway.

- i) Enable the DHCP Server on Ethernet port N1 by pressing “5”.
- ii) Press “Y” <Enter> to enable. “N” will disable the DHCP Server.
- iii) Press any key to continue and escape back to the main menu. Press “!” to restart the gateway.

When connecting a PC or Laptop to the gateway on port N1, be sure to enable the DHCP Client function on the PC or Laptop. The following screen-shot from the Network Connection's properties on a Windows PC shows the TCP/IP settings needed to enable the PC's DHCP Client:

Select TCP/IP and then properties

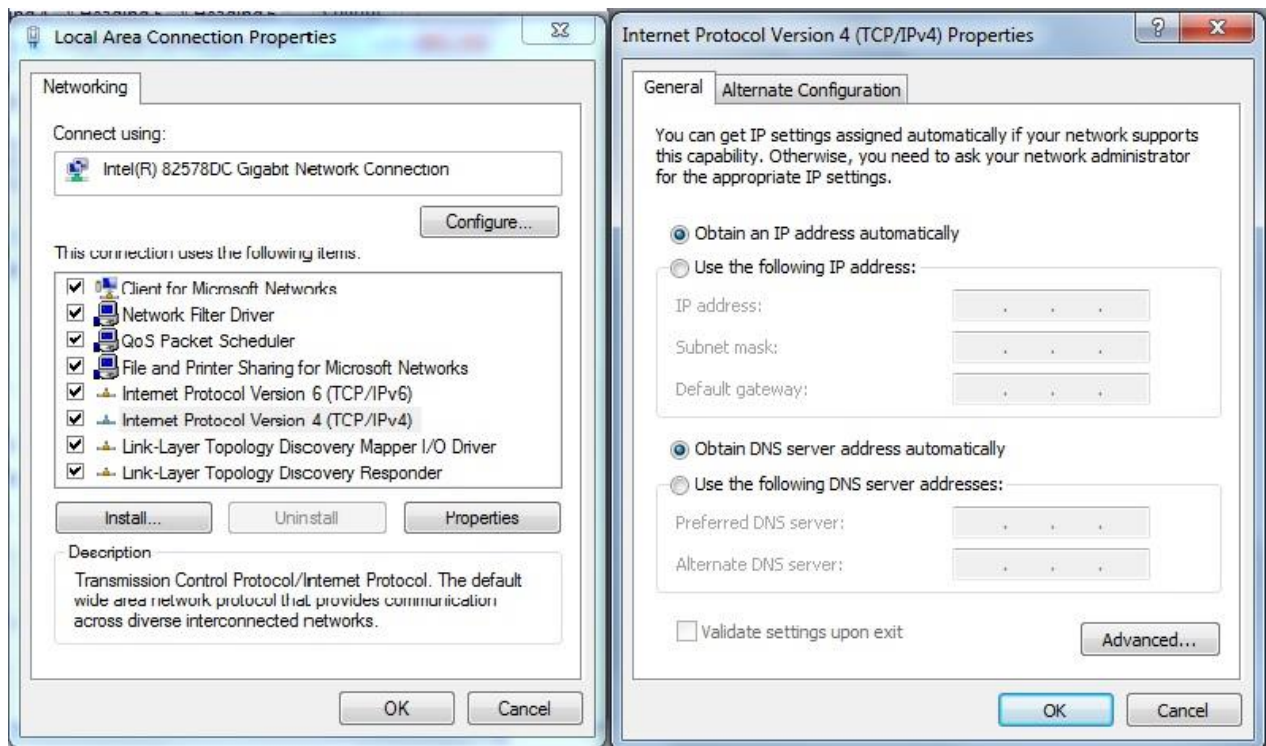

Simply restart the PC while connected to the gateway and it will obtain an IP address from the gateway.



San Telequip (P) Ltd.,  
504 & 505, Deron heights, Opp Mahabaleshwar hotel  
Baner Road, Baner Pune 411 045  
Phone : 020-, 65001587  
email : [info@santelequip.com](mailto:info@santelequip.com)



NOTE: Some implementations of the Microsoft DHCP Client will not use an IP address lease offered by the gateway until its previous lease has been released. The way to release and renew a lease on a PC is to open a command prompt window and use the following commands (syntax may be different on Windows other than XP):

```
ipconfig /release *  
ipconfig /renew *
```

The gateway checks every few minutes for the existence of other DHCP Servers and will disable itself if any are detected. A message on the Ruinet E screen will indicate when the DHCP Server has been disabled.

Also subnet netmask, DHCP settings and gateway settings can be changed in the above settings.

#### 4.16 Restart the gateway

Push the ! (Shift+1) key to restart the gateway. All stats and message screens will be cleared and connections with remote devices closed. Ruinet will display the main interactive menu again after the gateway has restarted.

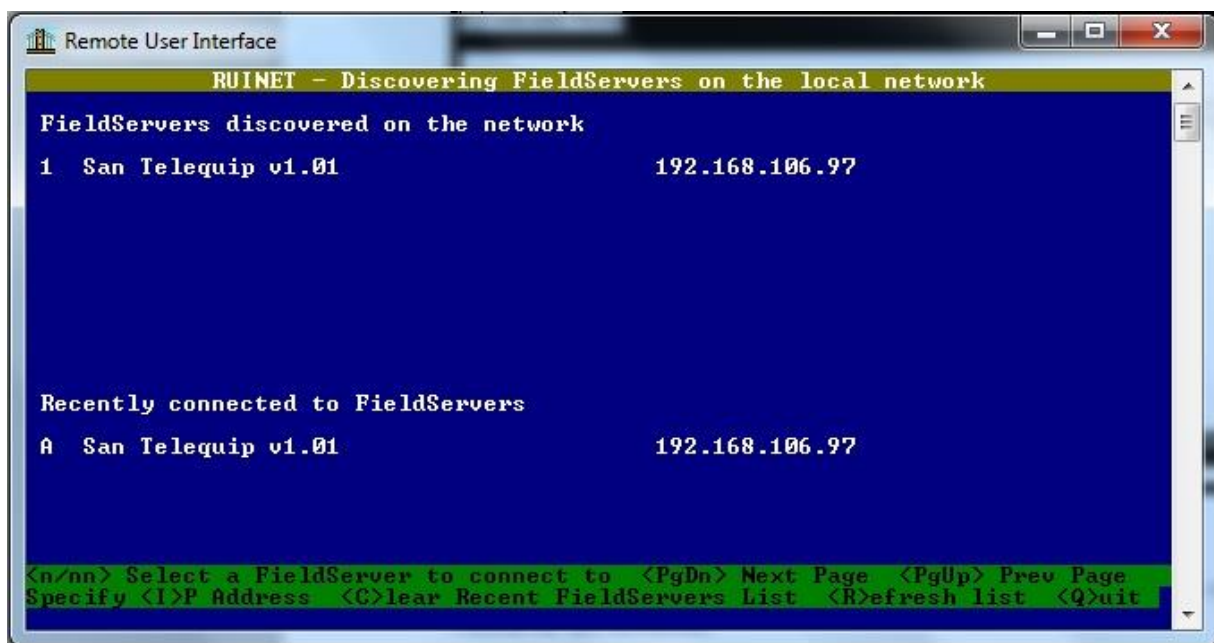

A utility called ruinet.exe is required to download driver configuration file into the gateway. The same utility is also used to change the IP address and configure other parameters of gateway.

Note:

If user has not provided the IP address to be assigned to the gateway, then gateway is shipped with default IP address 192.168.1.200 and subnet mask 255.255.255.0 with DHCP disabled. If user wants to change the IP address of the gateway, then procedure is mentioned as below.

## 5 USE THE WEB GUI TO CONNECT TO THE GATEWAY

Note: Only For GW BMS 01-02, GW BMS 03 & GW BMS 04 Units

### Overview

The GW BMS 01-02 has a web-browser based User Interface, and uses a combination of technologies and devices to provide a platform that the user can interact with for the tasks of easily gathering and producing information.

### GUI allows the user to:

1. Check the status and diagnostics of a FieldServer including such information as network settings, connection info, node information, map descriptors, and error messages
2. Monitor a working Gateway's internal data and parameters
3. Change or update a Gateway's internal data and parameters
4. Transfer files to and from a Gateway
5. Delete files on a Gateway
6. Change the Gateway's IP address
7. Restart a Gateway

### 5.1 Using the Web Browser to launch GUI (Graphic User Interface):

Connect the Gateway to pc through straight ethernet cable and power on the unit. Type the IP address of gateway directly into the web browser and press enter, GUI will be launch.

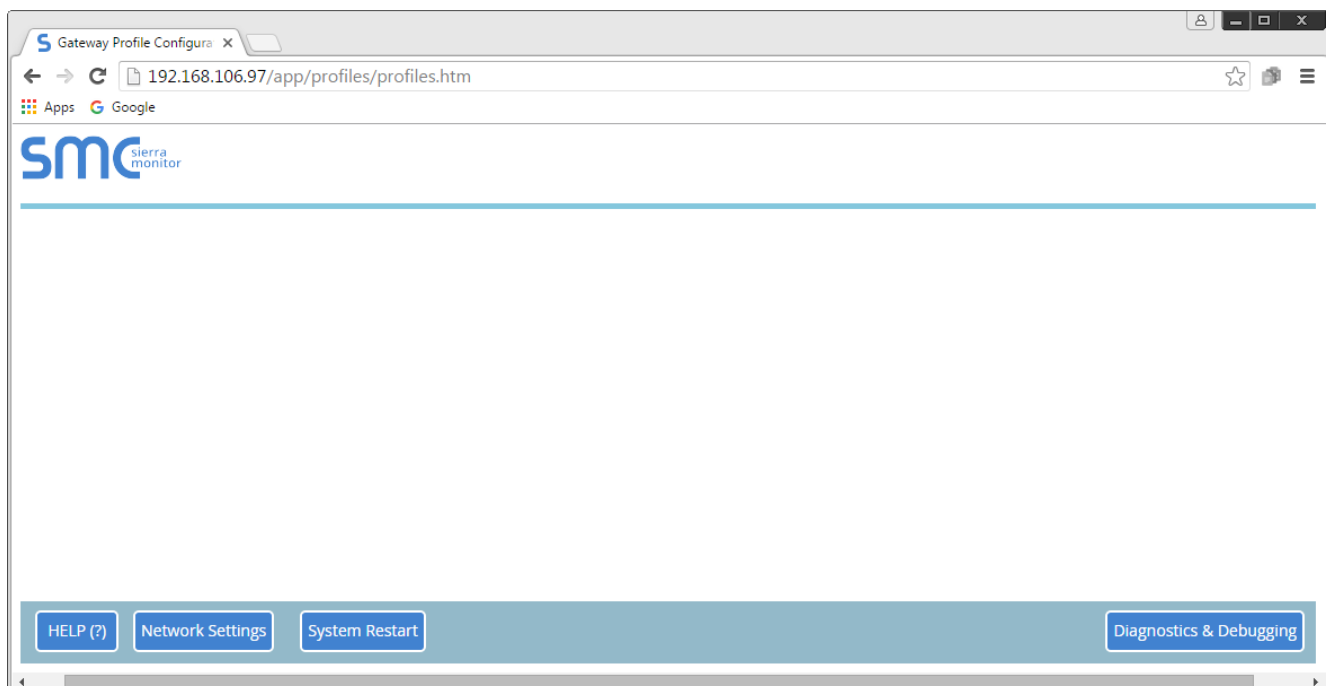

There are four buttons as follows

San Telequip (P) Ltd.,  
504 & 505, Deron heights, Opp Mahabaleshwar hotel  
Baner Road, Baner Pune 411 045  
Phone : 020-, 65001587  
email : [info@santelequip.com](mailto:info@santelequip.com)



### 5.2 Help:

It shows the information about the contents such as Configuration parameters, Active profiles, and available profiles.

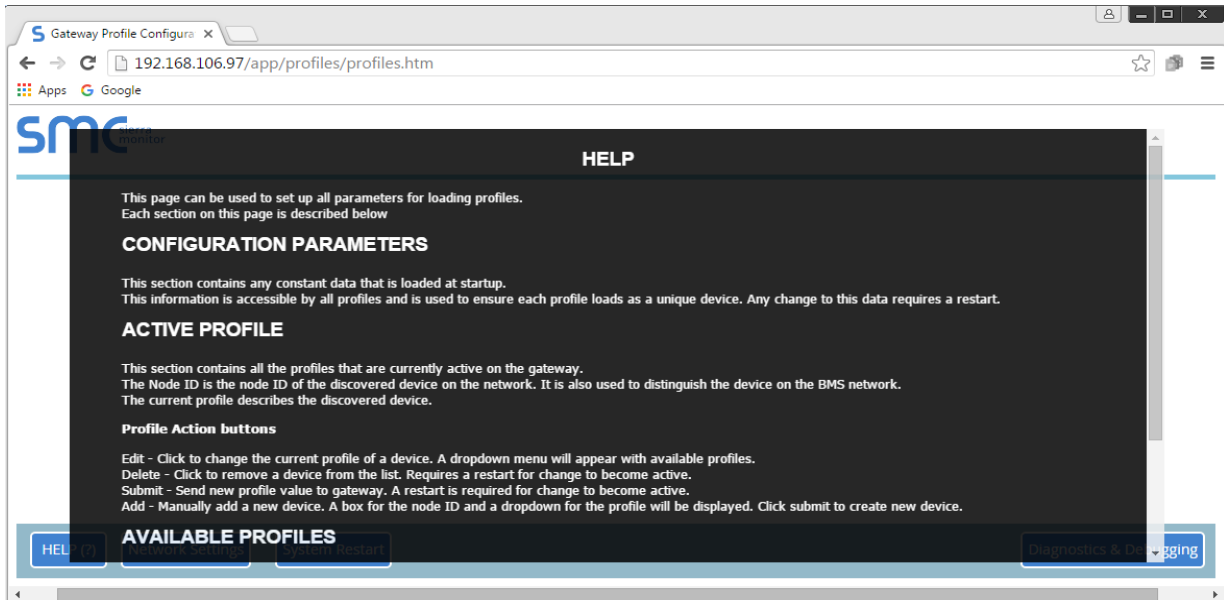

### 5.3 Network Setting:

Here we can set the IP address, Netmask, Gateway, DNS & DHCP network settings for the gateway. Uploaded setting only takes effect after System Restart.

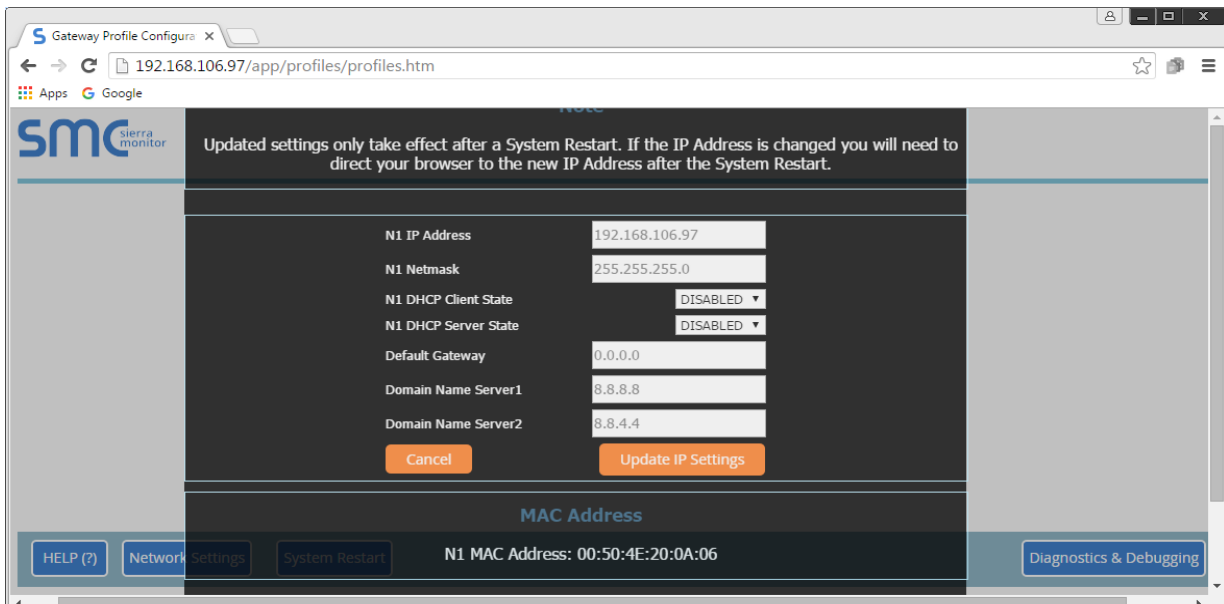

San Telequip (P) Ltd.,  
 504 & 505, Deron heights, Opp Mahabaleshwar hotel  
 Baner Road, Baner Pune 411 045  
 Phone : 020-, 65001587  
 email : [info@santelequip.com](mailto:info@santelequip.com)



**5.4 System Restart:**

The gateway can be restart by using this button. After pressing System Restart button press 'OK' to restart take effect. It will take 15-20 sec to restart gateway.

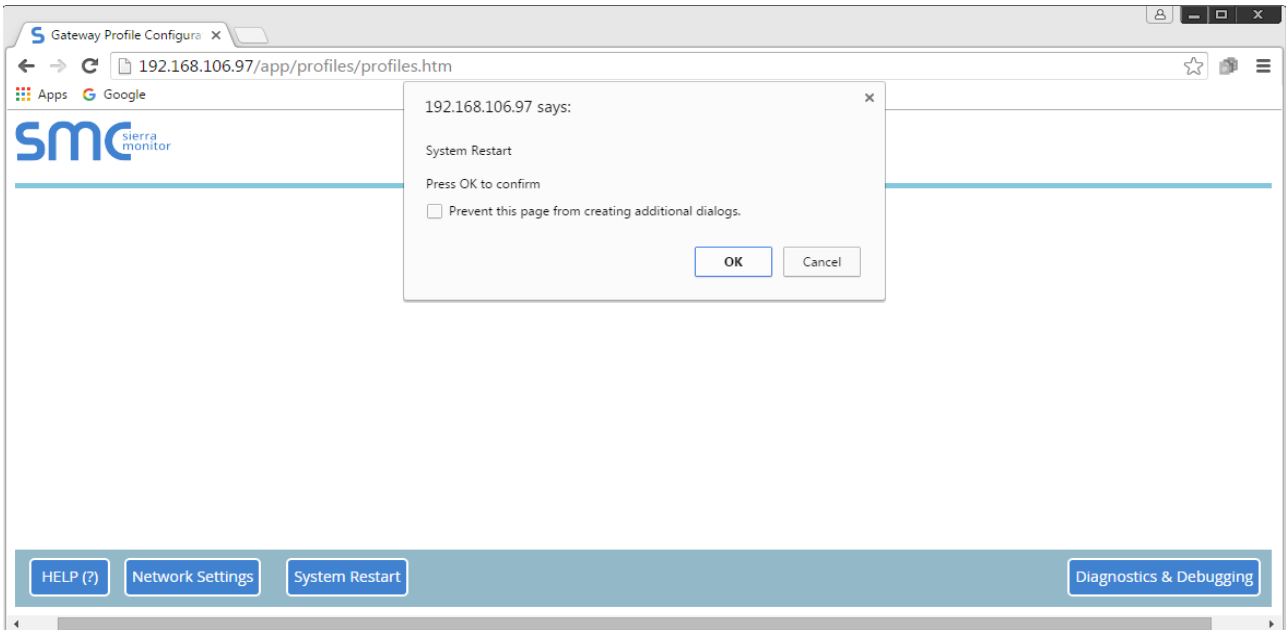

**5.5 Diagnostics & Debugging:**

After selecting this button following window will be open.

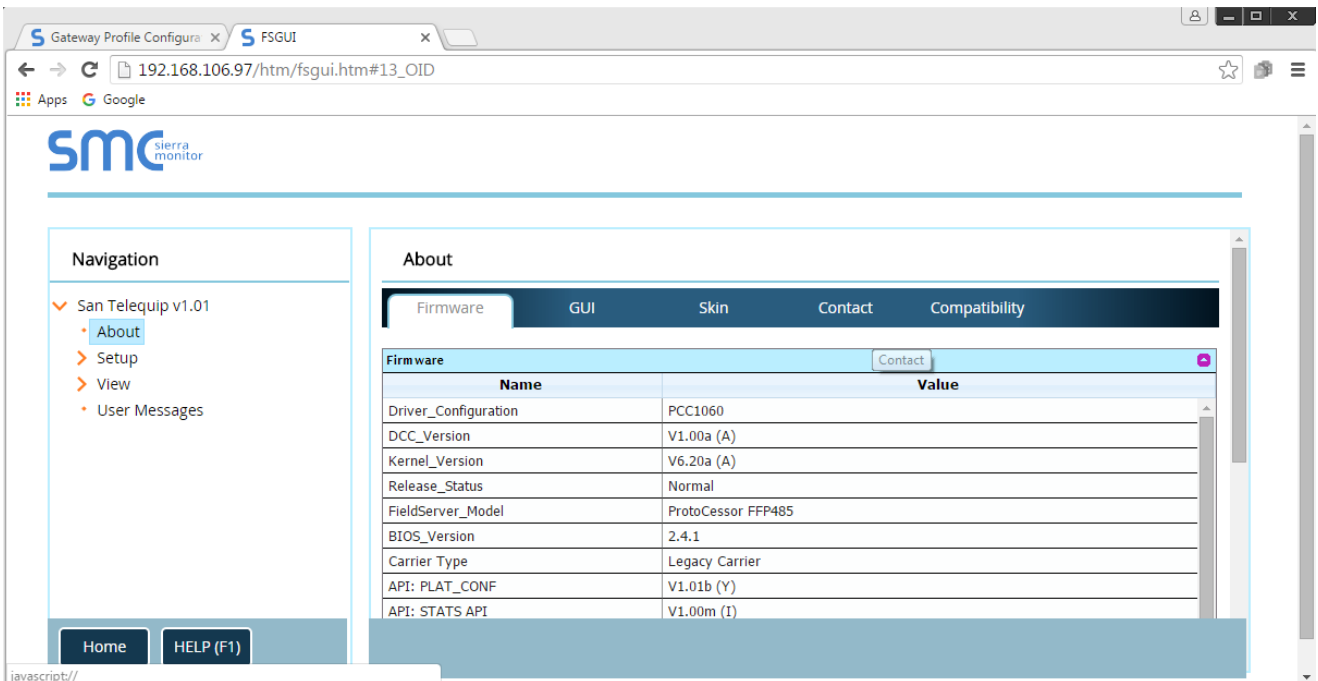

## 6 NAVIGATION TREE

### 6.1 Root

The root of the navigation tree allows the user to check the status of the gateway, including the configuration code, version, memory, gateway type and more. Under "Settings" the user has access to important network information. The name of the root is specified in the Gateways Configuration file under the Title Keyword.

### 6.2 About

Allows the user to check current firmware of the gateway plus version identification of the interface and skin. Skin is either the default gateway template or it can be a specific template specified by the owner.

### 6.3 Setup

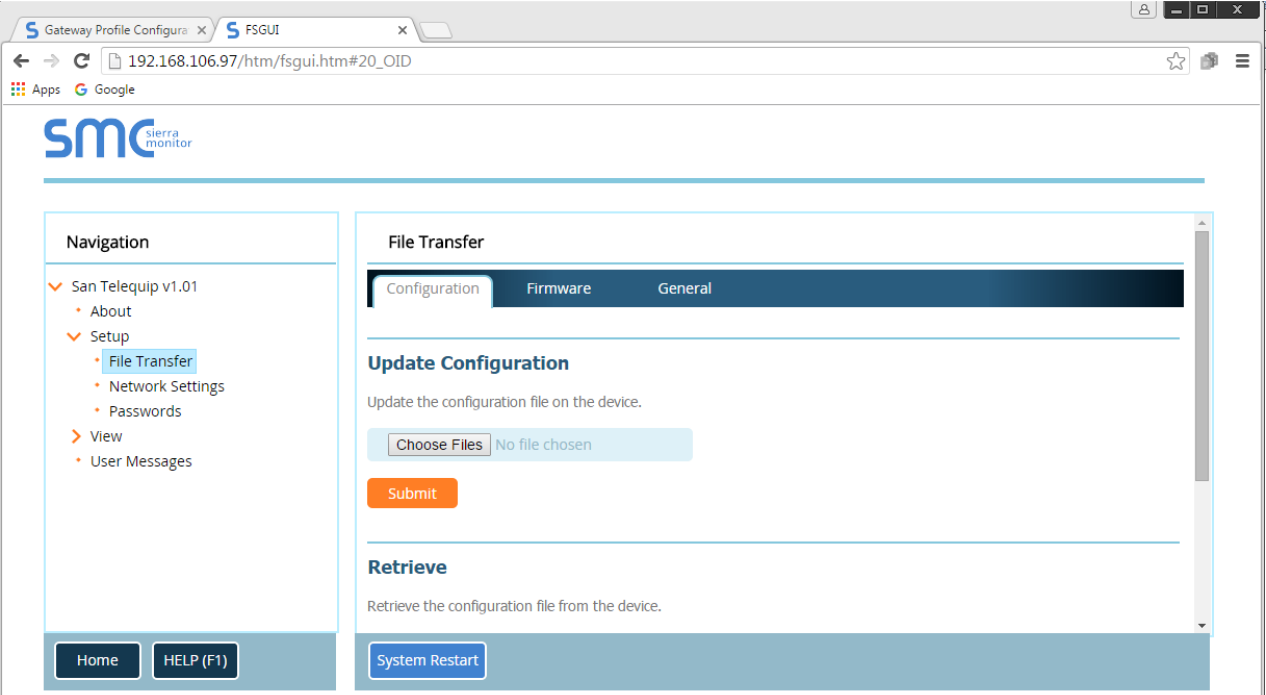

The screenshot displays the SMC Sierra Monitor FSGUI interface. The browser address bar shows the URL [192.168.106.97/htm/fsgui.htm#20\\_OID](http://192.168.106.97/htm/fsgui.htm#20_OID). The interface features a navigation tree on the left with the following structure:

- San Telequip v1.01
  - About
  - Setup
    - File Transfer (highlighted)
    - Network Settings
    - Passwords
  - View
  - User Messages

The main content area is titled "File Transfer" and includes three tabs: "Configuration" (selected), "Firmware", and "General". Under the "Configuration" tab, there are two sections:

- Update Configuration**: Includes the instruction "Update the configuration file on the device." and a "Choose Files" button (currently showing "No file chosen") followed by a "Submit" button.
- Retrieve**: Includes the instruction "Retrieve the configuration file from the device."

At the bottom of the interface, there are three buttons: "Home", "HELP (F1)", and "System Restart".

### 6.3.1 File Transfer

There are 3 types of files that can be transferred, namely Configuration Files, Firmware and Miscellaneous (general) files.

#### 6.3.1.1 Configuration Files:

Configuration files have a .csv extension, and are used to configure the gateway for its specific application.

- To Update the configuration file

To update the Gateway's configuration file, click the browse button and select the configuration file (.csv). Click open, and submit. Wait until the message "Configuration update complete" appears, and click the System Restart button to activate the new configuration file.

- To Retrieve the configuration file

For making changes to the configuration file: Retrieve the file, edit it, save the updated file and update the file

- To Delete the configuration file

To temporarily disable the Gateway's protocol communications, the configuration can be deleted. The Gateway needs to be restarted to activate the changes.

Warning: This action cannot be undone - make sure you have saved a copy of your configuration file.

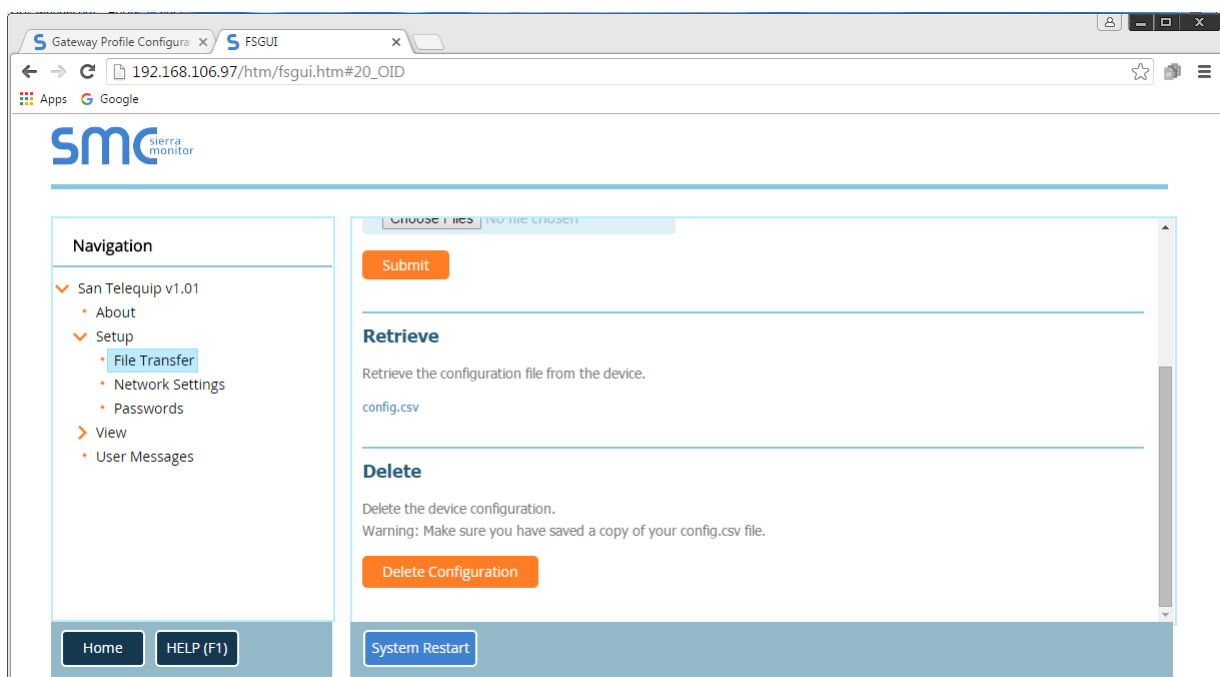

### 6.3.1.2 Firmware Files:

The Gateway Firmware contains the application program commonly referred to as the DCC or the PCC. This program contains the protocol drivers applicable to the application and the FieldServer Operating System Kernel.

A Firmware update is only required when updated files are received from service support. Firmware files have a .bin extension.

### 6.3.1.3 General (Other) Files:

Other files can be updated, the procedure for updating these is the same as for configuration files, but the update needs to be made in the “General” update section.

## 6.3.2 Network Settings

On the Network Settings Page, the Ethernet adaptor settings of the Gateway can be changed. The N1 and N2 (if supported) adaptor IP address, Netmask, and default Gateway can be changed by entering values in the applicable fields and clicking on the Update IP settings Button.

NOTE: The Gateway has to be restarted for any changed settings to take effect. Also note that enabling the DHCP client on any adaptor will cause the static IP address settings to be overruled by a DHCP server on the network.

The Gateway’s built-in DHCP server can be enabled to establish easy connection for Support purposes. Set the laptop or computer to automatically obtain an IP address to use this feature. Note that the FieldServer DHCP server periodically checks for other DHCP servers on the network and will disable itself should any other DHCP servers exist on the network. This mode of operation is because the Gateway DHCP server is strictly for support purposes and does not have all the features of a commercial DHCP server. Setting the default gateway IP address to your network gateway will ensure the BMS converter is reachable on the internet.

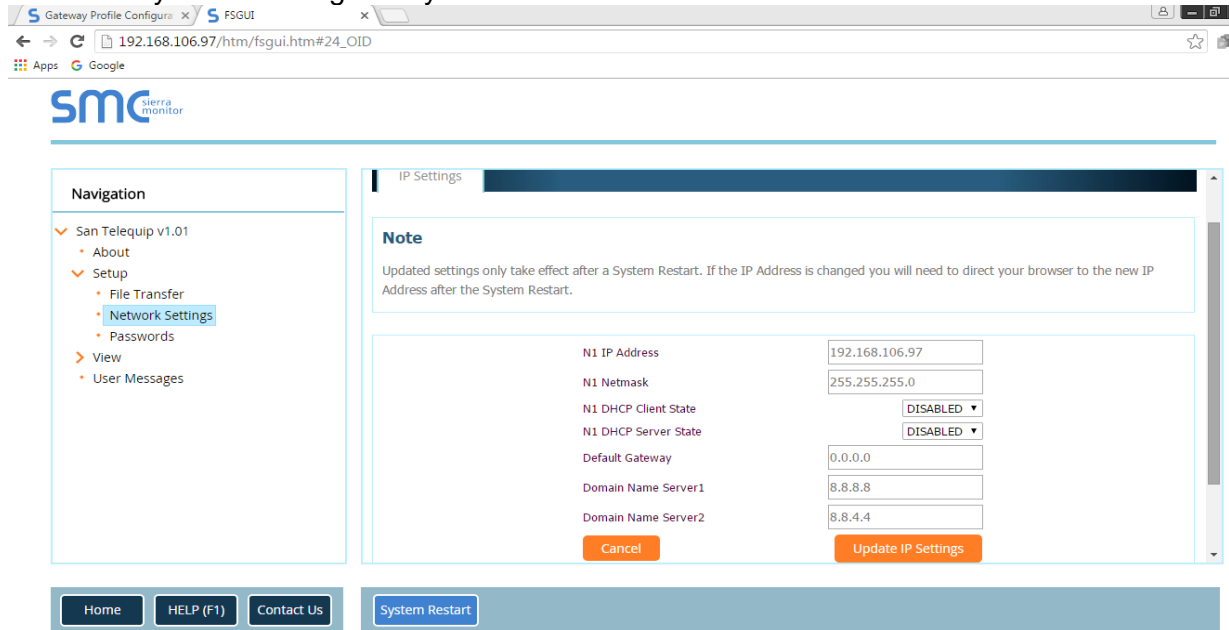

The screenshot displays the 'IP Settings' configuration page. On the left, a navigation pane shows 'San Telequip v1.01' with sub-items: 'About', 'Setup' (expanded), 'File Transfer', 'Network Settings' (highlighted), 'Passwords', 'View', and 'User Messages'. The main content area has a title bar 'IP Settings' and a 'Note' box: 'Updated settings only take effect after a System Restart. If the IP Address is changed you will need to direct your browser to the new IP Address after the System Restart.' Below this are several form fields: 'N1 IP Address' (192.168.106.97), 'N1 Netmask' (255.255.255.0), 'N1 DHCP Client State' (DISABLED), 'N1 DHCP Server State' (DISABLED), 'Default Gateway' (0.0.0.0), 'Domain Name Server1' (8.8.8.8), and 'Domain Name Server2' (8.8.4.4). At the bottom of the form are 'Cancel' and 'Update IP Settings' buttons. A 'System Restart' button is located at the bottom of the page, along with 'Home', 'HELP (F1)', and 'Contact Us' buttons.

### 6.3.3 Passwords

Access to the Gateway can be restricted by enabling a password. There are 2 access levels defined by 2 account names: Admin or User.

The Admin account has unrestricted access to the Gateway

The User account can view any Gateway information, but cannot make any changes or restart the Gateway.

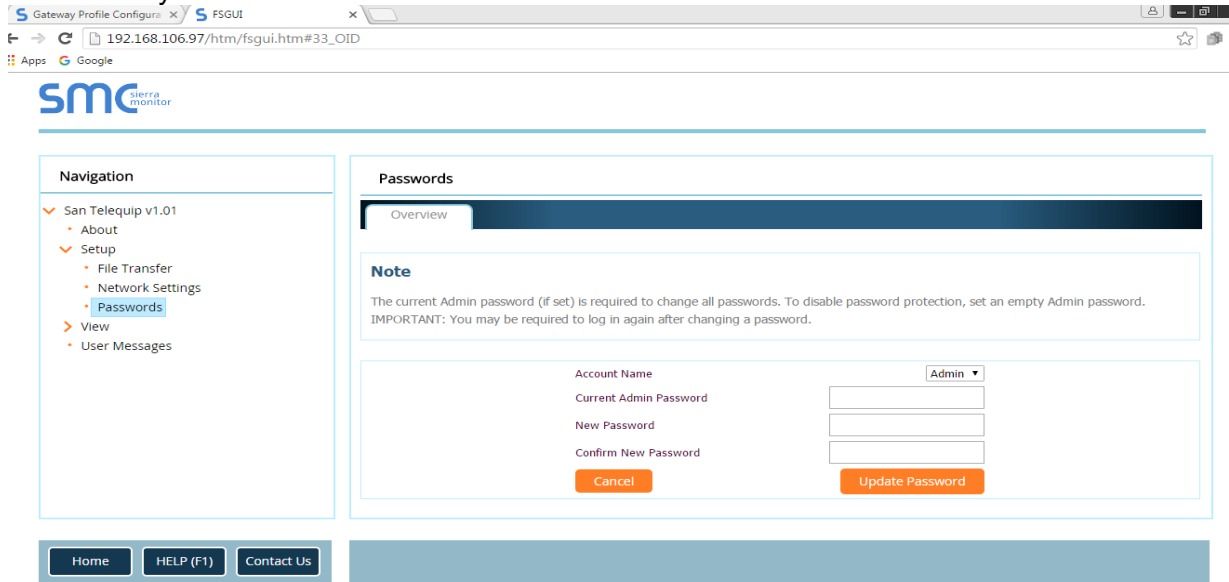

The screenshot shows the 'Passwords' configuration page. On the left is a navigation menu with 'Passwords' selected. The main content area has a 'Note' stating that the current Admin password is required for changes and that password protection can be disabled by setting an empty password. Below the note is a form with the following fields:

- Account Name: Admin (dropdown menu)
- Current Admin Password: [text input]
- New Password: [text input]
- Confirm New Password: [text input]

At the bottom of the form are two buttons: 'Cancel' and 'Update Password'. The footer contains 'Home', 'HELP (F1)', and 'Contact Us' buttons.

### 6.4 View

#### 6.4.1 Connections

The Connections screen supplies information on communication between the Gateway and remote devices. A number of aspect screens are available, including settings, info stats and error stats. The information on these screens cannot be changed, and is for viewing only.

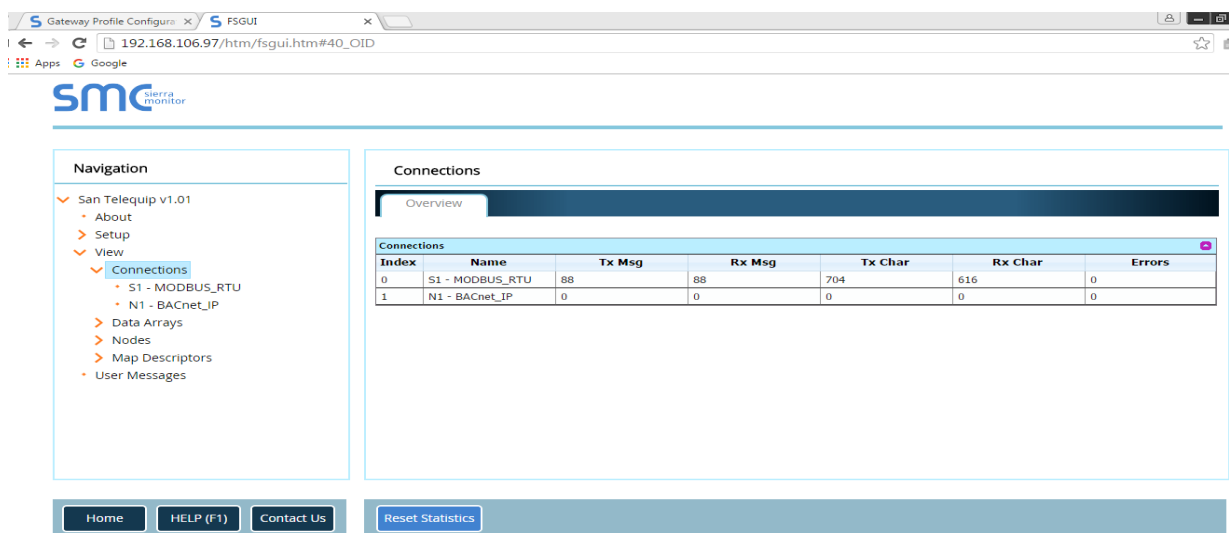

The screenshot shows the 'Connections' overview page. The navigation menu on the left has 'Connections' selected. The main content area displays a table with connection statistics:

Index	Name	Tx Msg	Rx Msg	Tx Char	Rx Char	Errors
0	S1 - MODBUS_RTU	88	88	704	616	0
1	N1 - BACnet_IP	0	0	0	0	0

Below the table is a 'Reset Statistics' button. The footer contains 'Home', 'HELP (F1)', and 'Contact Us' buttons.



### 6.4.2 Data Arrays

The Data Arrays screens can be used to view the values in Data Arrays. The values can be changed by clicking on the “Enabled Grid”- button, and changing the value in the data array grid. Note that if values are being written into the Array by a driver, then any modifications made by grid editing will be overridden.

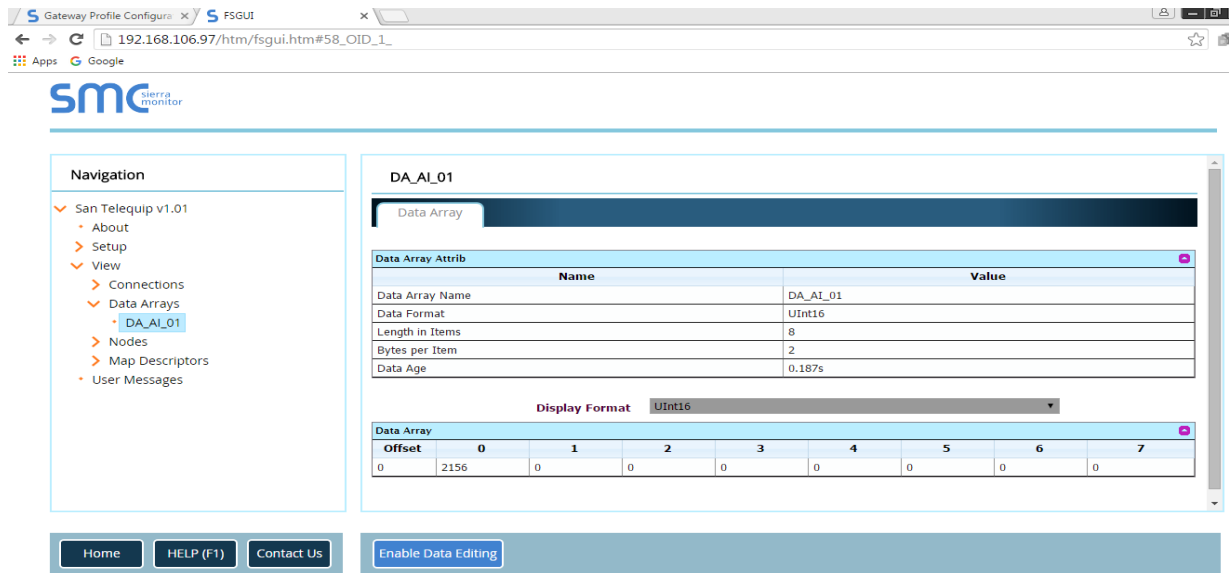

The screenshot shows the 'Data Array' configuration page for 'DA\_AI\_01'. The left navigation pane is expanded to 'Data Arrays' > 'DA\_AI\_01'. The main content area displays the following details:

Data Array Attrib	
Name	Value
Data Array Name	DA_AI_01
Data Format	UInt16
Length in Items	8
Bytes per Item	2
Data Age	0.187s

Below the details, there is a 'Display Format' dropdown set to 'UInt16' and a 'Data Array' grid:

Offset	0	1	2	3	4	5	6	7
0	2156	0	0	0	0	0	0	0

At the bottom, there are buttons for 'Home', 'HELP (F1)', 'Contact Us', and 'Enable Data Editing'.

### 6.4.3 Nodes

On the Nodes screens information about the remote devices on each connection can be viewed. A number of aspect screens are available, including settings, status, info stats and error stats. The information on these screens cannot be changed, and is for viewing only.

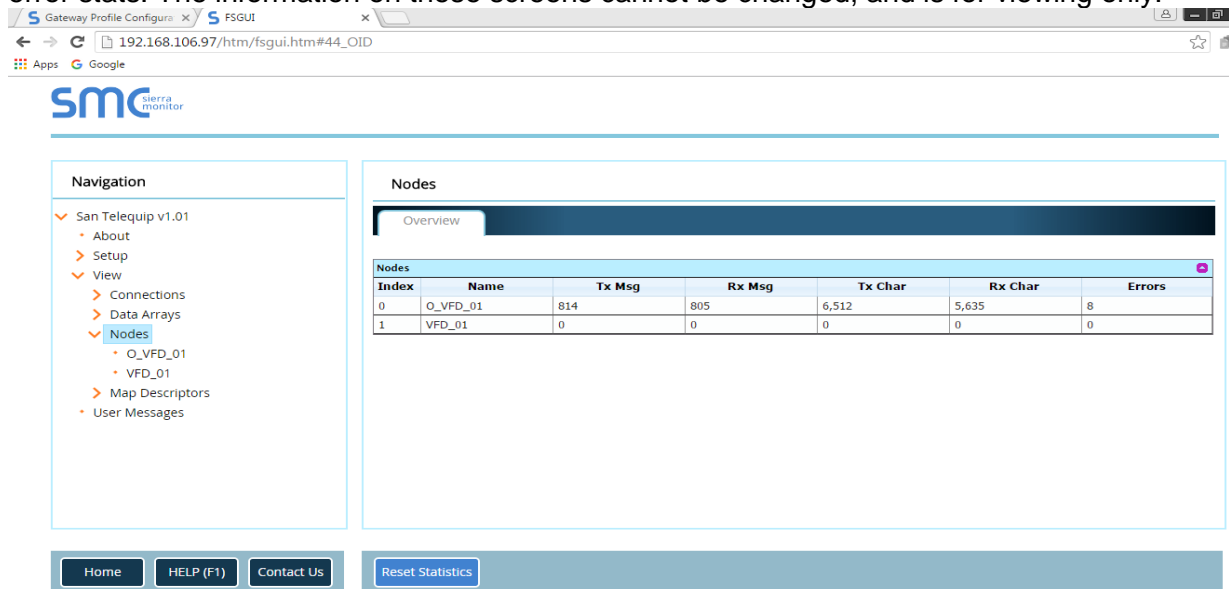

The screenshot shows the 'Nodes' overview page. The left navigation pane is expanded to 'Nodes' > 'VFD\_01'. The main content area displays the following table:

Nodes							
Index	Name	Tx Msg	Rx Msg	Tx Char	Rx Char	Errors	
0	O_VFD_01	814	805	6,512	5,635	8	
1	VFD_01	0	0	0	0	0	

At the bottom, there are buttons for 'Home', 'HELP (F1)', 'Contact Us', and 'Reset Statistics'.

## 6.4.4 Map Descriptors

On the Map Descriptors screens information on each individual Map Descriptor can be viewed. A number of aspect screens are available, including settings, status, info stats and error stats. The information on these screens cannot be changed, and is for viewing only.

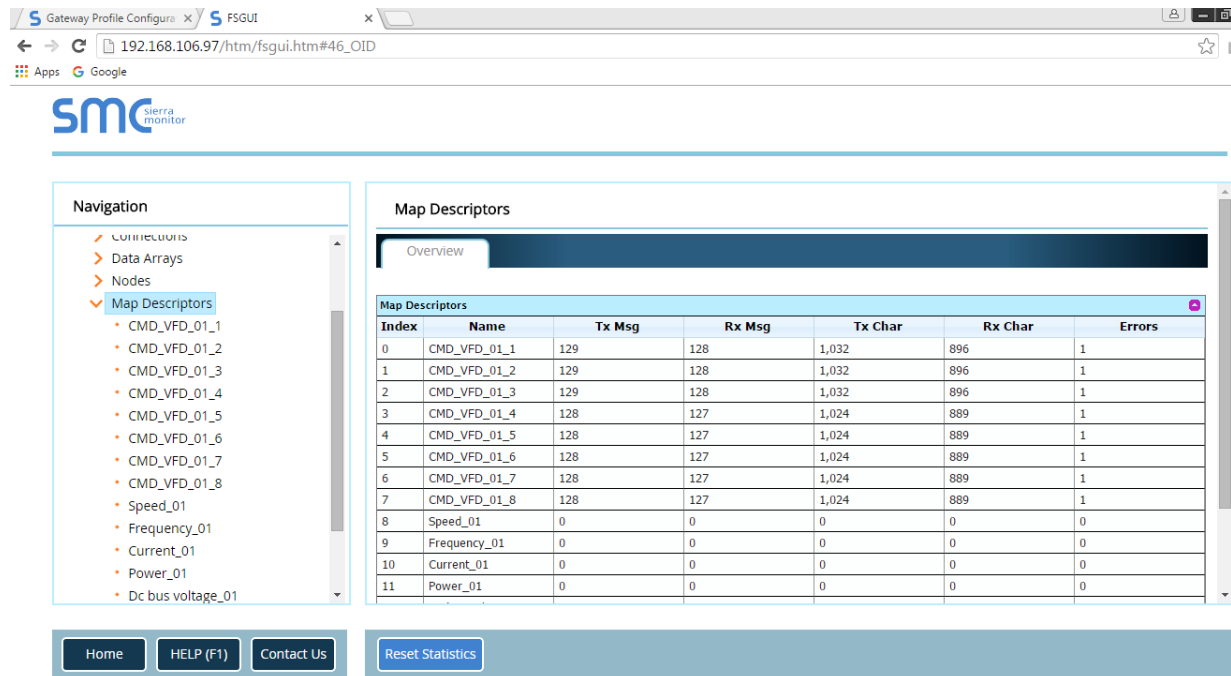

The screenshot shows the SMC Sierra Monitor web interface. The navigation menu on the left includes: Connections, Data Arrays, Nodes, and Map Descriptors (selected). Under Map Descriptors, there is a list of descriptors including CMD\_VFD\_01\_1 through CMD\_VFD\_01\_8, Speed\_01, Frequency\_01, Current\_01, Power\_01, and Dc bus voltage\_01.

The main content area displays the "Map Descriptors" screen with an "Overview" tab. Below the tab is a table with the following data:

Index	Name	Tx Msg	Rx Msg	Tx Char	Rx Char	Errors
0	CMD_VFD_01_1	129	128	1,032	896	1
1	CMD_VFD_01_2	129	128	1,032	896	1
2	CMD_VFD_01_3	129	128	1,032	896	1
3	CMD_VFD_01_4	128	127	1,024	889	1
4	CMD_VFD_01_5	128	127	1,024	889	1
5	CMD_VFD_01_6	128	127	1,024	889	1
6	CMD_VFD_01_7	128	127	1,024	889	1
7	CMD_VFD_01_8	128	127	1,024	889	1
8	Speed_01	0	0	0	0	0
9	Frequency_01	0	0	0	0	0
10	Current_01	0	0	0	0	0
11	Power_01	0	0	0	0	0

The footer contains buttons for Home, HELP (F1), Contact Us, and Reset Statistics.

## 6.5 User Messages

The user message screens display Gateway messages generated by drivers and the operating system.

User messages on the "Error"- screen usually indicate some problem with the configuration or communication and should be attended to.

User messages of an informational type will be displayed on the "Info"- screen, and no user action is usually required.

Messages generated by protocol drivers will be displayed on the "Driver"- screen. These messages convey protocol specific information that can be useful for field integration purposes.

Finally the "Combined"- screen contains all messages chronologically from all the above message screens.

San Telequip (P) Ltd.,  
504 & 505, Deron heights, Opp Mahabaleshwar hotel  
Baner Road, Baner Pune 411 045  
Phone : 020-, 65001587  
email : [info@santelequip.com](mailto:info@santelequip.com)

The screenshot shows a web browser window displaying the San Telequip web interface. The browser's address bar shows the URL "192.168.106.97/htm/fsgui.htm#85\_OID". The interface includes a navigation menu on the left with options like "About", "Setup", "View", and "User Messages". The main content area is titled "User Messages" and has tabs for "Errors", "Info", "Driver", and "Combined". Below these tabs is a table with the following structure:

Timestamp	Message
03/04 14:23	No Messages

At the bottom of the interface, there are buttons for "Home", "HELP (F1)", "Contact Us", and "Clear Messages".

## 7 PROCEDURE TO CONFIGURE BACnet Router GW BMS 02-02R

1. Connect the GWBMS02-02R to the network using straight patch chord. The PC and gateway should be on same subnet.
2. Open a web browser on PC and put IP address of BACnet router.  
e.g. If gateway IP address is 192.168.1.200, put this IP into browser. (PC IP should be 192.168.1. X). Web page settings will open as shown in below snapshot.
3. To change the IP addresses of router go to Network Setting Option. Put new IP and press System restart.
4. To set the BACnet MSTP-1 Port baud rate, make changes in 'BACnet MSTP R2' Setting.
5. To set the BACnet MSTP-2 Port baud rate, make changes in 'BACnet MSTP R1' Setting.
6. After all configuration changes, press system restart.

San Telequip (P) Ltd.,  
 504 & 505, Deron heights, Opp Mahabaleshwar hotel  
 Baner Road, Baner Pune 411 045  
 Phone : 020-, 65001587  
 email : [info@santelequip.com](mailto:info@santelequip.com)

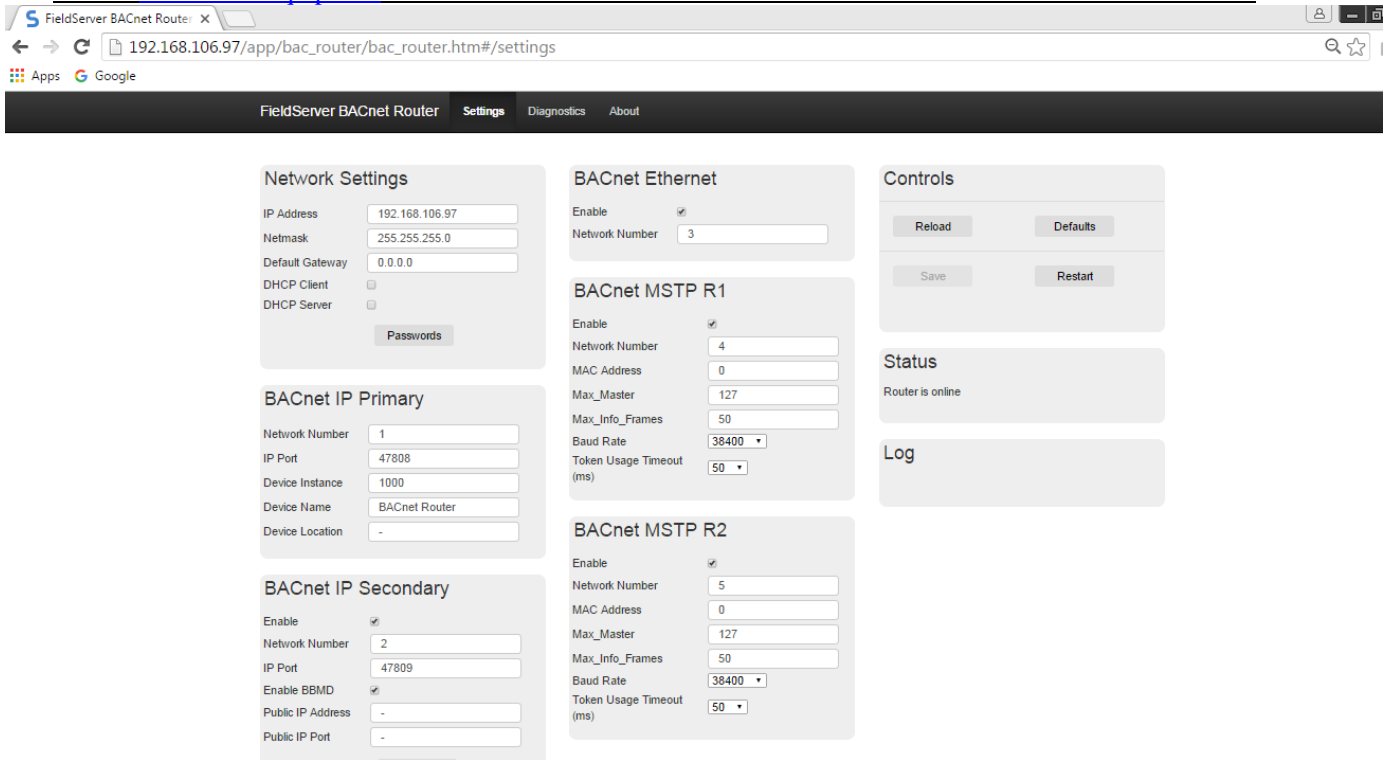

### 7.1 BACnet Router GW BMS 02-02R Connection Diagram

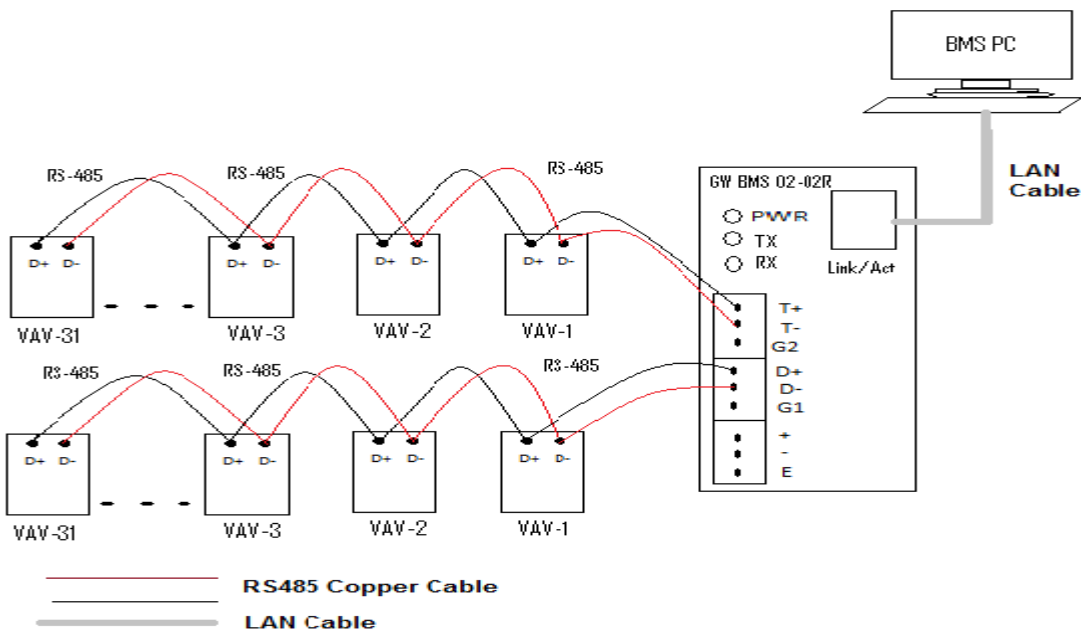

## 8 SNMP FUNCTIONALITY

Note: For GW BMS 05 unit.

### 1. Using BMS gateway as a SNMP client

Following figure shows connection details when gateway is used as a SNMP client.

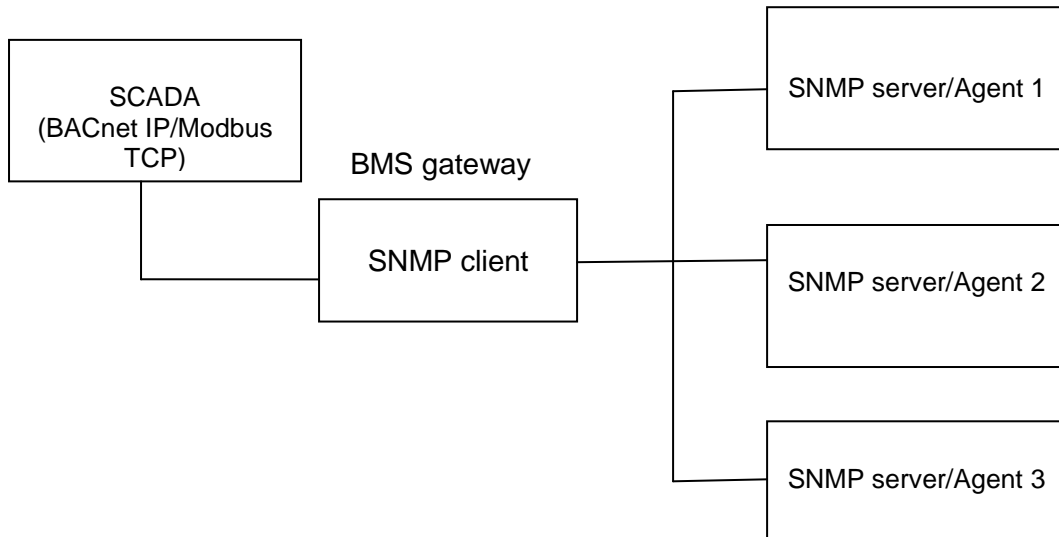

When gateway is used as a SNMP client, it will communicate with SNMP agents/servers connected on the network and provide data to the SCADA on different protocol (e.g. BACnet IP/ Modbus TCP). In order to establish communication with the SNMP servers, configuration file needs to be downloaded in the gateway. This configuration file will contain parameters like IP addresses of SNMP servers and mapping details. Each SNMP server will have its own MIB file. The object identifiers mentioned in this MIB file will be used for mapping device parameters.

### 2. Using BMS gateway as a SNMP server

Following figure shows connection details when gateway is used as SNMP server. BACnet IP is shown as other non-SNMP protocol.

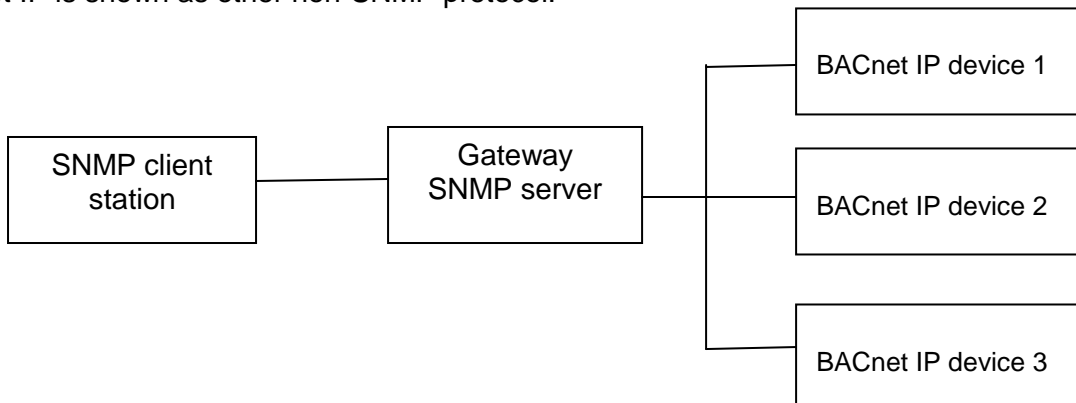

Gateway will communicate with BACnet IP devices using node IDs and object IDs of these devices which are configured through CSV file downloaded in the gateway. After configuration of the gateway, MIB file is generated through ruinet utility. This MIB file is loaded into SNMP client software to establish connection with the gateway. After completion of above setup, SNMP client station can communicate to the BACnet IP devices.

## 9 CONNECTION DETAILS

NAME	DETAILS
24 V AC/ DC (+,- and E)	Connect 24 V AC/DC supply.
Ethernet port/BACnet IP	Host / field protocol support (BACnet IP in GW BMS 01, GW BMS 02, GW BMS 03, GW BMS 01-02, GW BMS 02-02R and SNMP in GWBMS05). & Also used for diagnostics purpose.
D+ and D-	Connect D+ and D- of Field devices.
TX+,TX-,RX+ and RX- (In case of 4 Wire device)	Connect TX+,TX-,RX+ and RX- wires of Field devices.(4 Wire Device)

## 10 LED INDICATIONS

LED name	Meaning
POWER	Unit is powered on.
TX	Channel is transmitting data.
RX	Channel is receiving data.
10/100M	ON-100 Mbps (100Base Tx)
	OFF-10Mbps
LINK/ACT	ON- Network Connected
	OFF- No network connected
	Blinking- Activity on the Ethernet port